

New Vanguard

OSPREY
PUBLISHING

Confederate Submarines and Torpedo Vessels 1861–65



Angus Konstam • Illustrated by Tony Bryan



ANGUS KONSTAM was formerly the Curator of Weapons in the Royal Armouries at the Tower of London, and has also served as the Chief Curator of the Mel Fisher Maritime Museum in Key West, Florida. He is currently based in Edinburgh, where he pursues a full-time career as a historian. He is the author of over 50 books, many of which are published by Osprey.



TONY BRYAN is a freelance illustrator of many years' experience. He initially qualified in Engineering and worked for a number of years in Military Research and Development, and has a keen interest in military hardware – armor, small arms, aircraft and ships. Tony has produced many illustrations for partworks, magazines and books, including a number of titles in the *New Vanguard* series.

CONTENTS

INTRODUCTION	3
CONSTRUCTION AND DEVELOPMENT	5
• Confederate torpedo boats: <i>David</i> and <i>Squib</i>	
• Confederate submarines: <i>Pioneer</i> , <i>Pioneer II</i> , and <i>H.L. Hunley</i>	
• Late-war torpedo boats	
OPERATION	20
• The torpedo	
• Torpedo boats in action	
• The attack of the <i>CSS H.L. Hunley</i>	
THE FORGOTTEN SUBMARINES	40
• The New Orleans submarine	
• Villeroi's first submarine	
• Cheeney's submarine	
• The <i>USS Alligator</i>	
• The <i>USS Intelligent Whale</i>	
• The <i>CSS St Patrick</i>	
BIBLIOGRAPHY	43
COLOR PLATE COMMENTARY	45
INDEX	48

Confederate Submarines and Torpedo Vessels 1861–65

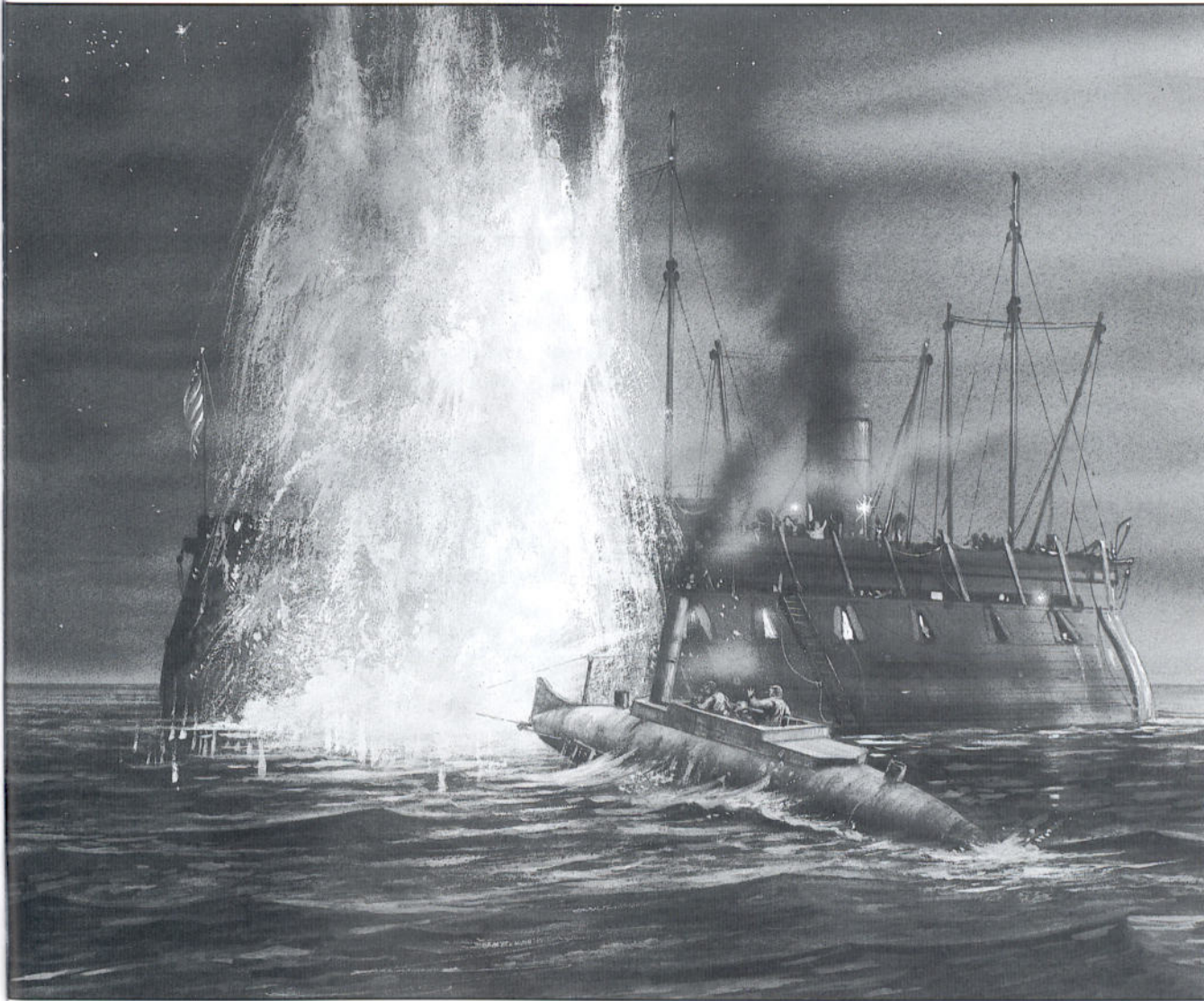

First published in Great Britain in 2004 by Osprey Publishing, Elms Court,
Chapel Way, Botley, Oxford OX2 9LP, United Kingdom.
Email: info@ospreypublishing.com

© 2004 Osprey Publishing Ltd.

All rights reserved. Apart from any fair dealing for the purpose of private study,
research, criticism or review, as permitted under the Copyright, Designs and
Patents Act, 1988, no part of this publication may be reproduced, stored in
a retrieval system, or transmitted in any form or by any means, electronic,
electrical, chemical, mechanical, optical, photocopying, recording or otherwise,
without the prior written permission of the copyright owner. Enquiries should be
addressed to the Publishers.

A CIP catalogue record for this book is available from the British Library.

ISBN 1 84176 720 4

Editor: Simone Drinkwater
Design: Melissa Orrom Swan
Index by David Worthington
Originated by The Electronic Page Company, Cwmbran, UK
Printed in China through World Print Ltd.

04 05 06 07 08 10 9 8 7 6 5 4 3 2 1

For a catalog of all books published by Osprey Military
and Aviation please contact:

Osprey Direct USA, c/o MBI Publishing, P.O. Box 1,
729 Prospect Ave, Osceola, WI 54020, USA
E-mail: info@ospreydirectusa.com

Osprey Direct UK, P.O. Box 140, Wellingborough,
Northants, NN8 2FA, UK
E-mail: info@ospreydirect.co.uk

www.ospreypublishing.com

Artist's note

Readers may care to note that prints of the original paintings from which
the color plates in this book were prepared are available for private sale.
All reproduction copyright whatsoever is retained by the Publishers. All
enquiries should be addressed to:

tonybill@tiscali.co.uk

The Publishers regret that they can enter into no correspondence upon
this matter.

CONFEDERATE SUBMARINES AND TORPEDO BOATS 1861-65

INTRODUCTION

When the Civil War began in April 1861, the Confederacy found itself on the strategic defensive. It had insufficient men and resources to defend its extensive border, and faced a hostile foe with an abundance of manpower, industrial capacity, and economic wherewithal. While this situation posed severe problems for the fledgling Confederate Army, the Confederate Navy faced an even more daunting challenge. When the South seceded from the Union, the North retained almost all of the old US Navy. Confederate Secretary of the Navy Stephen Mallory was faced with the prospect of protecting an extensive coastline with only a fraction of the resources available to his Union counterpart.

Mallory had to rely on the static defense of selected points such as the ports of Norfolk, Charleston, Savannah, Mobile, and New Orleans, while blocking Union access to the rivers and waterways which led deep into the Confederate heartland. To augment these static defenses, Mallory ordered the construction of a fleet. Unable to match the Union Navy in numbers, he opted for a smaller quantity of technologically advanced warships to even the odds, the most famous of which were the Confederate ironclads such as the CSS *Virginia* (formerly *Merrimac*), which fought the

first duel between two ironclads in March 1862. Several similar vessels were constructed from Richmond to the tributaries of the Mississippi River, but gradually it was realized that these vessels were not the answer. Lumbering, underpowered, and usually outnumbered, they were soon integrated into a defensive system that included forts and shore batteries as well as warships.

Faced with a seemingly unbreakable ring of blockading warships around his coasts, Mallory sought ever more ingenious ways to break the Union stranglehold. Torpedoes (what we would now call mines) were only just being developed, and Mallory embraced this new technology, drawing on the advice of Southern engineers and ordnance experts to design static torpedoes that were soon deployed to protect the rivers and harbors of the Confederacy. He then took the idea one stage further and sought ways to use this torpedo technology in an offensive way, against the Union fleet. The result was a series of experimental and seemingly hazardous designs for surface boats and submersibles that offered the chance to transport

Confederate Secretary of the Navy Stephen Mallory (1812-73) was a gifted strategist and naval innovator who embraced new technology as a means of countering the Union superiority in ships and men. (Stratford Archive)



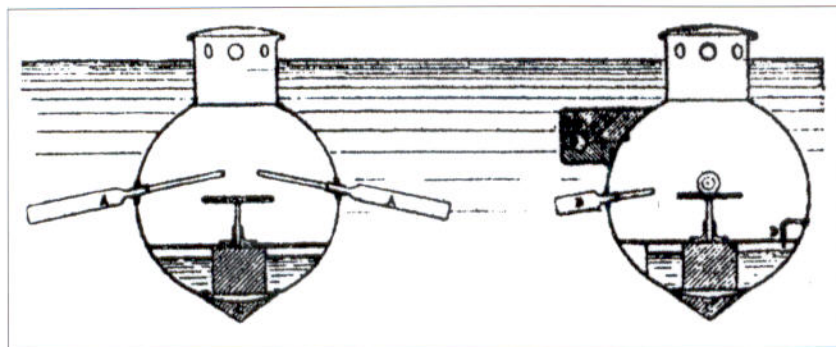

A depiction of David Bushnell's *Turtle*, c. 1775. This one-man submarine resembled a small barrel with oars attached, but she was the first submarine in history to attack a surface warship. (Stratford Archive)

a torpedo to the enemy, then strike him with it. These designs resulted in some of the most amazing vessels of the war – craft which, as the pioneers of later destroyers and submarines, would change the face of naval warfare forever.

The war saw the development of small steam-powered torpedo boats, which could approach an enemy without being seen, then attack and sink a warship of far greater size. Even more spectacular were the submarines built during the war – warships which, for the first time, were able to fight in three dimensions rather than two. Although the exploits of the CSS *H.L. Hunley* have been well documented and the story of her rediscovery and salvage became front-page news around the world, there is far more to the story than this remarkable boat, the world's first submarine to sink an enemy warship. Several submarines were built by both sides during the war, and although these other experimental craft were ultimately less successful than the *H.L. Hunley*, their designers tackled and solved some of the problems which have faced submariners ever since. These included the problems of air supply, propulsion, reliable torpedo delivery systems, and underwater steering. While the designers of Civil-War-era surface torpedo boats faced fewer problems than their submariner counterparts, the craft they produced became increasingly sophisticated and reliable as the war progressed.

The submarine was not a new phenomenon. Alexander the Great was reported to have dived inside an air-filled bell, and during the American Revolution, on September 6, 1776, David Bushnell's small one-man submersible, the *Turtle*, attacked but failed to destroy the British third-rate ship of the line HMS *Eagle* as she lay at anchor off New York. General George Washington described the *Turtle* as an "effort of genius," but the attempt was never repeated. Bushnell's experiments were repeated by fellow American Robert Fulton (1765–1815), who built two submarines during the Napoleonic Wars. He tried to sell his plans to both the British and the French, but without success. A few years later, in 1813, a British warship was unsuccessfully attacked off New London, Connecticut, by an unidentified submarine.

By the start of the Civil War, both sides were well aware that submarines could be used offensively, and for years newspapers had carried stories of experimental craft designed in Europe. Unlike the craft designed by Bushnell and Fulton, who only had augers and gunpowder at their disposal, these new craft would be able to use a range of sophisticated explosive devices, making them primitive but deadly weapons of war. In April 1861, several intrepid engineers of both sides decided to try to build

their own submersibles, so beginning the story which would lead to the groundbreaking sinking of the USS *Housatonic* by the CSS *H.L. Hunley*. While this book concentrates on Confederate submarines and torpedo vessels, where appropriate, Union vessels are also covered, as they played a part in the development of these revolutionary Confederate warships.

CONSTRUCTION AND DEVELOPMENT

Confederate torpedo boats: *Torch*, *David*, and *Squib*

During the first years of the war, the Confederates concentrated on the production of defensive torpedoes, and these were laid in increasing numbers to defend seven harbors and rivers from the Mississippi to the Atlantic coast. However, the improvement of torpedo firing systems and the development of a workable spar torpedo mechanism raised the possibility of the offensive use of the torpedo by the Confederates.

A proponent of the spar torpedo was army engineer Lieutenant Francis D. Lee, who converted an unwanted 20ft-long ship's longboat into an oar-powered torpedo boat by fitting an explosive device to the end of a spar, or long pole, fixed to the bow of the vessel. The explosive was pushed into the side of a ship and detonated. On March 13, 1863, he demonstrated the effectiveness of the vessel and his spar design by destroying a hulk anchored in Charleston Harbor. Although his craft was dubbed a "canoe," it was used to attack the screw sloop USS *Powhatan* off Charleston Harbor. The attack might well have succeeded, but a panic-stricken helmsman on the boat altered course just before the torpedo made contact with the sloop's hull, and the attack was aborted. At least the attack demonstrated that Lee's weapon would work given the right circumstances and a resolute crew.

More rowing boats were placed at the disposal of Lee, who converted these craft into oared spar torpedo boats, crewed by a naval detachment seconded to him "on special service," men who could be trusted to operate the vessels without repeating the failure of the *Powhatan* attack. However, as the months passed no clear opportunity presented itself.

A spar torpedo head and boom, as fitted to the Union Alpha Class tugs which entered service in 1864. The device was exploded by pulling a lanyard attached to an artillery friction tube. (Stratford Archive)

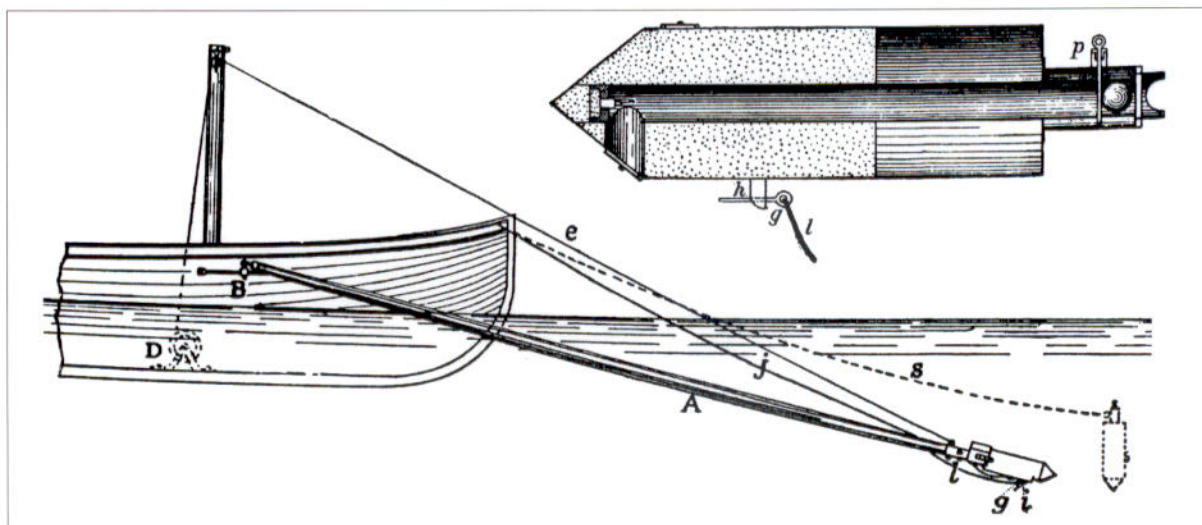

Given the lack of propulsion, these vessels would have had great difficulty operating far from the shelter of the harbor, and could not be operated in anything other than ideal conditions. Their greatest limitation was their lack of mechanical propulsion. Also, tests showed that the relatively slight construction of these rowing craft meant that they would be prone to damage following the explosion of the torpedo, and their hulls afforded no protection to the crew. The solution was a well-built steam-powered vessel.

The newly promoted Captain Lee submitted plans for a steam-powered spar torpedo vessel to his superior, General P. G. T. Beauregard, the victor at First Manassas, and now the commander of the Charleston defenses. He approved of this notion, and as a result the Confederate Navy gave Lee the unfinished hull of a Maury Class gunboat, one of a class of 100 planned vessels, of which only two were actually completed. As first designed, these vessels were wooden hulled, with an overall length of 106ft, a beam of 21ft, and a draft of 5ft. They were designed to be powered by twin screws, and displaced around 166 tons. Lee cut the vessel down to the waterline, then built a wooden turtle-backed casemate over the top of it, giving the vessel the appearance of a half-sized Confederate ironclad. She was officially classified as an ironclad ram. Lee's original plans called for an armored vessel, but a lack of armor plate meant that she first went to sea without any armored protection.

In December 1862, he wrote to Beuregard's chief-of-staff, Brigadier-General Jordan, stating that:

I am exceedingly anxious to commence bending the iron plating for marine torpedo ram. ... The hull of the boat is now nearly completed, and the workmen are now engaged in caulking the seams and preparing the clamps. ... I have collected ... a full supply of cast-iron for prow, and hope to be enabled to supply ... the necessary fire-wood to work the machinery. The delay in this matter has been occasioned by want of transportation on the South Carolina Railroad. ...

The armor never appeared.

Another problem was the vessel's propulsion system, a single screw powered by a less-than-reliable engine. Despite these difficulties, Lee completed the rebuilding of the vessel, and by late July 1863 he announced it was ready for limited action, although she still lacked any armor plate. Although he never named her at the time, she was later designated as the

America was not the only country to experiment with spar torpedoes during this period. This photograph from 1863 shows a British spar torpedo boat undergoing evaluation trials in the English Channel. (Museum of Naval Firepower, Portsmouth)



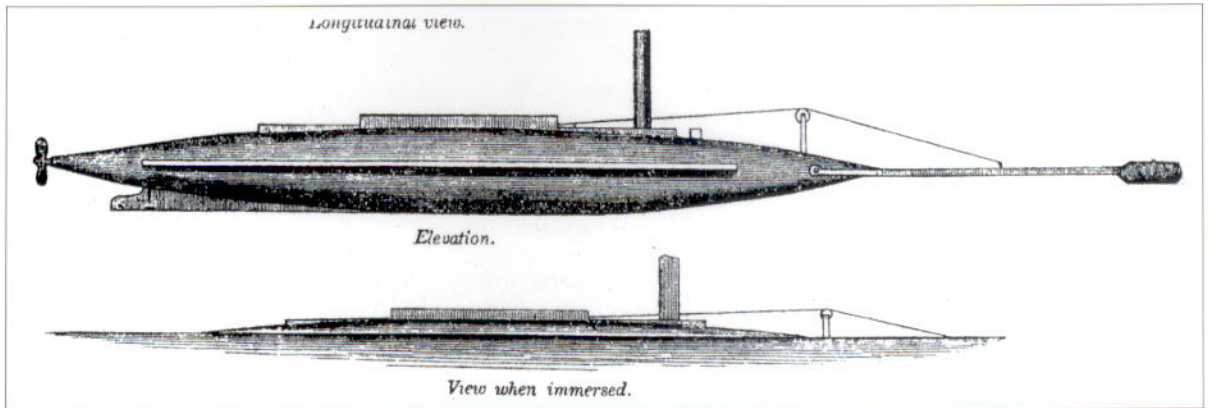

A David Class torpedo boat, showing her side elevation and her profile when in the water. These craft rode so low in the water that only the wheelhouse combing and the smokestack were visible. (Stratford Archive)

CSS *Torch*. She became the first torpedo boat to enter Confederate service. Her engines might have been weak, but she was equipped with a specially designed spar torpedo system mounting no less than three torpedoes. Despite her strange appearance, this untried vessel packed a powerful punch. On August 21, 1863, the *Torch* attacked the USS *New Ironsides*, but her engine failed at the critical moment, and the attack was aborted, her crew considering themselves lucky to escape with their lives. It appears she was never used again, as her worn and secondhand engine proved to be too unreliable to risk making another attempt. Although less than successful, the *Torch* served as the prototype for a new generation of privately built Confederate torpedo boats which would prove altogether more effective.

In early 1863, a group of Charleston businessmen formed the Southern Torpedo Company and, aided by their staff of South Carolinian shipwrights and engineers, they designed and constructed a privately funded torpedo boat, which they called the *David* because of the biblical disproportion in size between her and her Goliath-like opponents. The vessel was built at Stoney Landing, some 30 miles up the Cooper River from Charleston, and the finished vessel was taken down to the city and loaned to the Confederate Navy. The impetus for this venture was the offer of a reward of \$100,000 in Confederate money to anyone who produced a vessel which could sink the *New Ironsides*.

The *David* was a cigar-shaped craft some 48ft 6in. long, with a diameter of 5ft. She was powered by a small but relatively powerful two-cylinder steam engine located toward her bow, which operated a single screw. The central 18ft of her hull formed an open cockpit located immediately behind her smokestack, which provided space for her crew of four men while affording them some degree of protection against small-arms fire. She was heavily ballasted, so that when she was underway little more than her smokestack and hatch combing were seen above the water, which made her look more like a submarine than a surface vessel. She was armed with a spar torpedo of Lee's design, angled downward from the bow so that the torpedo itself rode some 6ft below the water. Following the *David's* unsuccessful attack on the *New Ironsides* on October 5, 1863, the spar was extended and hinged so it could be angled down more; it was felt that the charge had detonated against the armored portion of the Union vessel's hull. These modifications meant that next time the charge would strike below the armor.

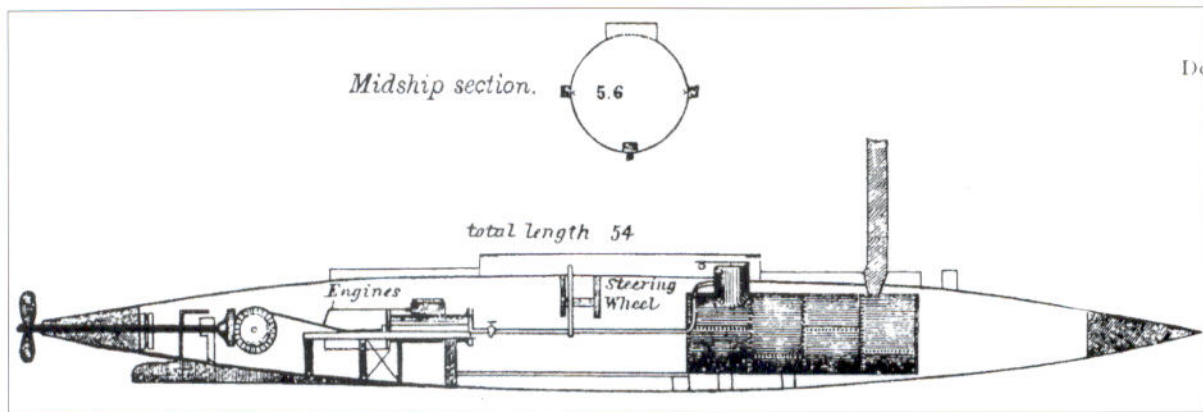

Two more (and slightly improved) gunboats of the David Class were also built at Stoney Landing, each around 50ft long, with a diameter of between 5ft 6in. and 6ft. These vessels (designated Torpedo Boats No. 1 and No. 2) entered service in 1864, and joined the *David* to form a torpedo boat squadron based in Charleston. All three vessels were abandoned when the city fell in February 1865. Three more vessels of the same class were built but were never fitted out, while another, improved version (designated Torpedo Boat No. 6) was nearing completion at Stoney Landing when the yards were captured and destroyed in February 1865 by Union troops from General Sherman's army. This last version of the David Class was probably 100ft long, with a diameter of 8ft, although one account describes a vessel 160ft long, with a diameter of almost 12ft. This latter size appears unlikely given the resources available to the Southern Torpedo Company at the time. Another smaller version of the *David* was built at Stoney Landing in 1864. The torpedo boat *Midge* was just 30ft long but had a diameter of 12ft, making her a shorter, squatter version, an adaptation imposed by the lack of suitable engines. The CSS *Midge* was not a success

The side elevation of a David Class torpedo boat. Much of her space was taken up by her boiler and small engine, but the design was well thought out, as the craft was well balanced and an efficient seaboat. (Stratford Archive)

A David Class torpedo boat beached at Charleston after the evacuation of the city in February 1865. The view gives a good impression of the shape of her hull, and her limited amount of wheelhouse space. (National Archives)

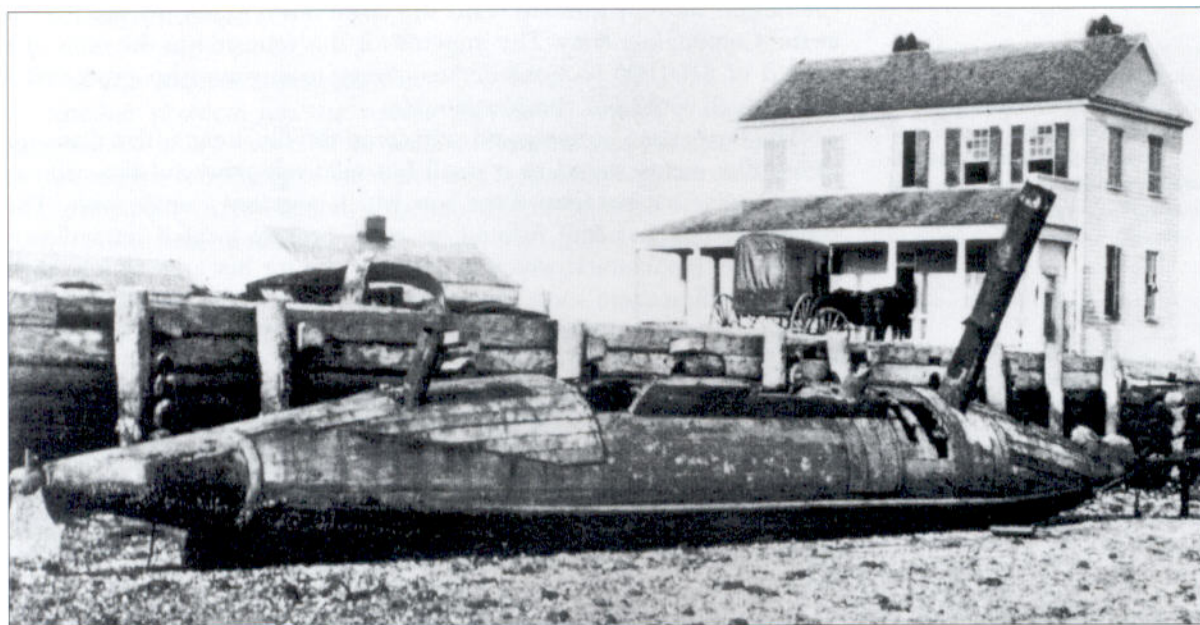



Torpedo boat *David* at Charleston Dock, October 25, 1863. Watercolor by Conrad Wise Chapman. (Museum of the Confederacy, Richmond, Virginia)

and was captured intact when Charleston was evacuated. She was later taken to Brooklyn Navy Yard, New York, where she was displayed until 1877, when she was sold for scrap. A final *David* Class boat was being constructed in Houston, Texas, when the war ended.

A different class of torpedo boat was designed in Richmond, Virginia, by the staff of the Torpedo Bureau, and built there by the Tredegar Ironworks. The first of these craft, the CSS *Squib*, entered service in the James River Squadron in early 1864. She was reputedly around 30ft long, with a beam of 6ft and a draft of 3ft. Designed along more conventional lines than the *David*, the *Squib* was essentially a semi-armored steam-powered launch. She was fitted with a small two-cylinder engine mounted amidships, while her boiler and smokestack were mounted aft, behind the conning position. She was fitted with a single screw. Her cockpit was raised slightly, and protected from small-arms fire by boiler plating.

On the night of April 9, 1864, the *Squib*, under the command of Lieutenant Hunter Davidson of the Torpedo Bureau sailed down the James River and attacked the powerful Union screw frigate USS *Minnesota*. Although the attack proved a failure, Davidson was commended for his bravery, and promoted to Commander. The *Squib* was then transported by rail to Wilmington, North Carolina, and operated on the lower Cape Fear River until the fall of Wilmington in early 1865. Three improved versions of the *Squib* Class entered service with the James River Squadron during the summer of 1864. These craft, the *Hornet*, *Scorpion*, and *Wasp*, were all 46ft long, with a beam of 6ft 3in., and a draft of 3ft 9in. Although they served as picket boats and improvised gunboats, they were all fitted with facilities to mount a spar torpedo, but there is no evidence that such a device was ever mounted in them. Work was also begun on a torpedo boat (probably another improved *Squib* Class) in Wilmington, North Carolina, but this vessel was destroyed by an accidental fire before she could be completed, along with two *Midge* Class torpedo boats which were being built for the Confederate Army. The *Hornet* and *Scorpion* were both lost in late January 1865, while the final fate of the *Wasp* is unknown, but she was probably destroyed when Richmond fell in April 1865.

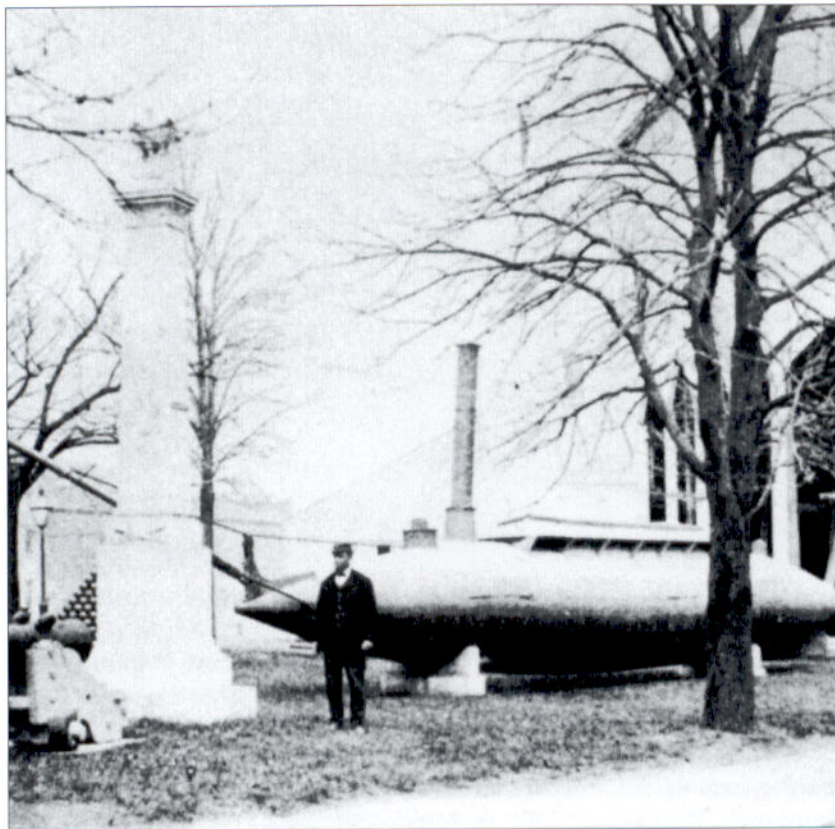

LEFT The Confederate torpedo boat *Midge*, photographed in New York's Brooklyn Navy Yard, c. 1870. The vessel was still fitted with a spar torpedo. (Naval Institute Press)

Confederate submarines: *Pioneer*, *Pioneer II*, and *H.L. Hunley*

At the start of the Civil War, submarines were practically unheard of, a mere footnote in the naval history of the American Revolution. However, in June 1861 the Southern scientist the Reverend Franklin Smith published a letter in several newspapers, calling for the creation of Confederate submarines. The letter even described the type of craft he meant: "The new vessel must be cigar-shaped for speed . . . made of plate iron, joined with external rivet heads; about 30ft long, with a central section about 4 x 3ft ... driven by a spiral propeller." He distributed plans to several municipal authorities.

Whether Reverend Smith's letter was the impetus for what followed is unrecorded, but shortly afterwards the New Orleans machinist James R. McClintock and his business partner, Baxter Watson, began work on a submersible. They owned a workshop where they manufactured parts for steam engines. They simply turned their attention to building the world's first privateering submarine instead. They were joined by Captain Horace L. Hunley, a successful lawyer and customs official from New Orleans. Hunley had already participated in gunrunning expeditions to Cuba on behalf of the Confederacy, and was probably enticed by the privateering aspect of the venture. By February 1862, the submarine was ready for trials, and was launched in New Orleans' New Basin Dock. She performed well, and with a few minor adjustments she was deemed ready to begin operations. The vessel was christened the *Pioneer*. After the war, McClintock described her as being:

RIGHT James McClintock of New Orleans was responsible for the creation of the *Pioneer* in 1861–62, and he played a leading part in the development of both the *Pioneer II* and the *H.L. Hunley* in Mobile, Alabama. (US Naval Historical Center, Washington, DC)

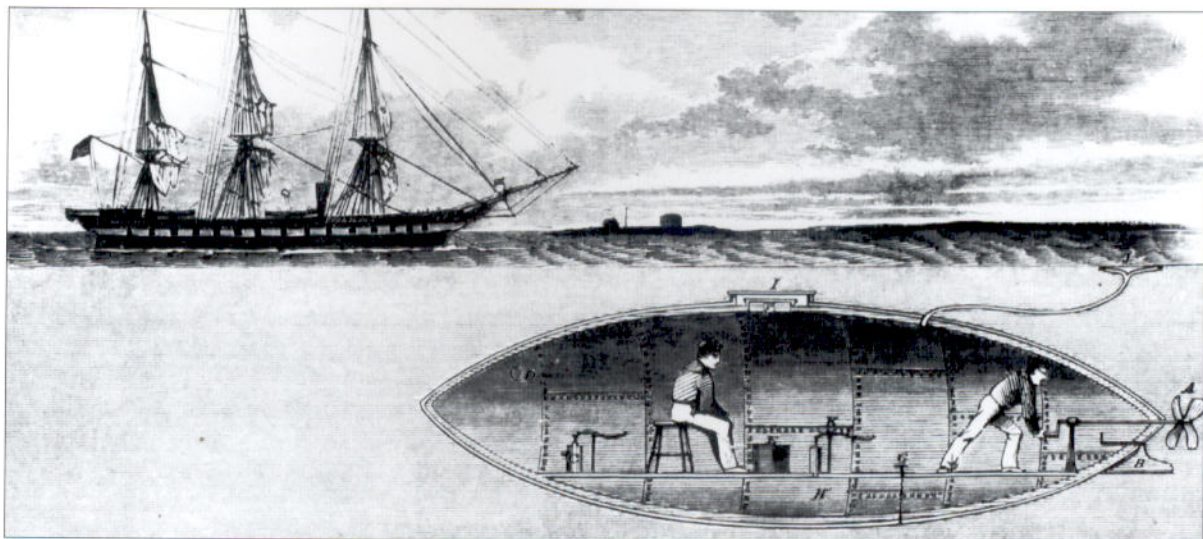

ABOVE An artist's impression of a Civil-War-era submarine. During the war the newspapers carried frequent depictions of these "infernal machines," many of which were far from realistic. From *Harper's Weekly*, November 1861. (Stratford Archive)

Made of iron $\frac{1}{4}$ -in. thick, the boat was a cigar shape 30ft long and 4ft in diameter. The boat demonstrated to us the fact that we could construct a boat that would move at will in any direction desired, and at any distance from the surface. As we were unable to see objects after passing under the water, the boat was steered by a compass, which at times acted so slow, that the boat would at times alter her course for one or two minutes before it would be discovered, thus losing the direct course, and so compel the operator to come to the top of the water more frequently than he otherwise would.

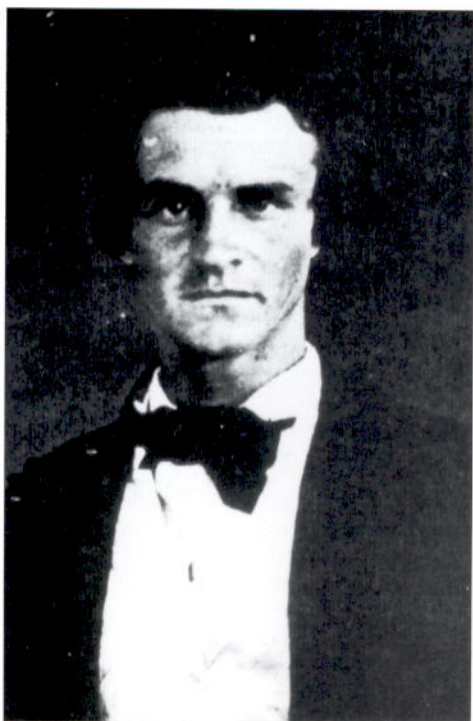

Incidentally, the dimensions McClintock mentions are virtually identical to those first proposed by the Reverend Smith. In her privateering Letter of Marque issued on March 31, 1862, the *Pioneer* was described as a "submarine propeller" armed with a magazine of powder. Her dimensions were given as 34ft from bow to stern and 4ft in diameter, with conical ends. Her commander was named as John K. Scott of New Orleans, a work colleague of Hunley. It was also noted that her hull was painted black to help conceal the craft when she was submerged. We know nothing of any service history, and in a postwar letter McClintock stated that "The evacuation of New Orleans lost the boat before our experiments were completed." It therefore seems that she was never used in anger. When New Orleans fell in late April 1862, the *Pioneer* was scuttled, although she was subsequently raised by Union engineers. The Union fleet engineer, Mr Shock, sent a report of the vessel to the Navy Department in Washington:

The boat was built of iron cut from old boilers, and was designed and built by Mr McClintock in his machine shop in the city of New Orleans. She was 30ft in length; the middle body was cylindrical, 10ft long, and the ends were conical. She had a small

REBEL SUBMARINE RAM

- A Compartment for compressed air
- B Compartment for water
- C Boat crew below
- D Pilot house
- E Guns moved by the lever H
- F Man hole plate

Scale $\frac{1}{4}$ " = 1'

G Suction screw by a wheel for drawing the current of a torpedo to a vessel.
H. Pump for pumping water in and out of B.

Length 35'
Diameter 4'

Submarine out for working the battery.
K. Head frame of the boat of which was

K. Platform on which torpedo rest, which being secured to the bottom

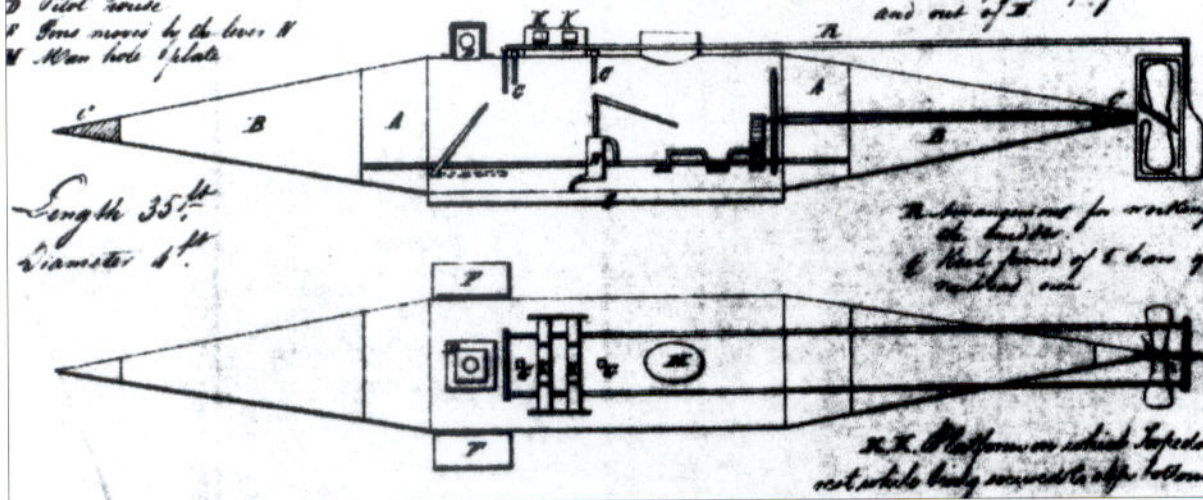

conning tower with a manhole in the top, and small, circular, glass windows in its sides. She was propelled by a screw, which was operated by one man. She had vanes, the function of which were those of the pectoral fins of a fish. The torpedo was of a clockwork type, and was intended to be screwed into the bottom of the enemy's ship. It was carried on top of the boat, and the screws employed were gimlet-pointed and tempered steel.

This sketch accompanied the official report to the Navy Department by the Union fleet engineer, Mr Shock, in mid-1862, and is probably a fairly accurate representation of the Confederate privateering submarine *Pioneer*. (National Archives)

Shock included a sketch of the vessel in his report, the only known contemporary depiction of the first Confederate submarine. An intriguing newspaper advertisement in 1868 described the sale by the US authorities of the "torpedo-boat" lying on the banks of the New Canal. It includes the information that "The boat in question, which is built of iron and weighs about two tons was sunk in the Canal about the time of the occupation of the city ... it was built as an experiment, and was never fully perfected, and is only valuable now for the machinery and iron which is in and about it." It is presumed that the *Pioneer* was subsequently sold for scrap.

After the fall of New Orleans, Scott joined the Confederate Army, while McClintock, Watson, and Hunley escaped to Mobile, Alabama, where they were allocated the use of the Park and Lyons Machine Shop so that they could build another submarine. This time they worked directly for the Confederate government, although funding for the project was provided by Hunley. Work in the shop was supervised by the British-born Lieutenant William A. Alexander. The result was the submarine known as the *Pioneer II*, or possibly the *American Diver*. No reliable contemporary plans exist of this vessel, but it can be assumed that she shared certain features of her predecessor, the *Pioneer*, and her successor, the *H.L. Hunley*. In a postwar letter, McClintock described this new craft:

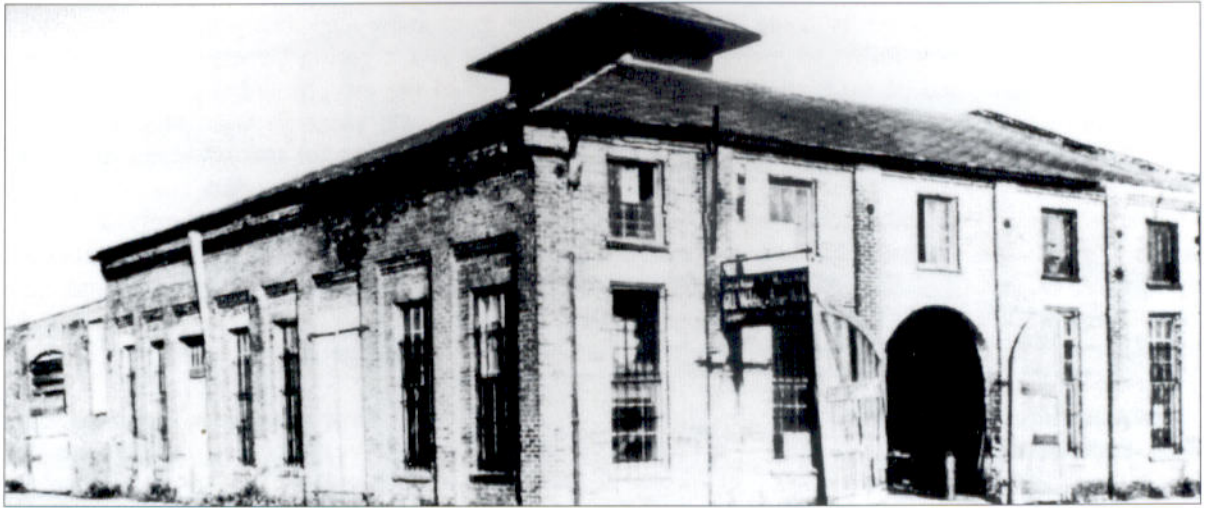

The Park and Lyons Machine Shop in Mobile, Alabama, the birthplace of both the *Pioneer II* and the *H.L. Hunley*. (US Naval Historical Center, Washington, DC)

We built a second boat at Mobile, and to obtain room for machinery and persons, she was made 36ft long, 3ft wide, and 4ft high. 12ft of each end were built tapering or molded, to make her easy to pass through the water.

From this description we can assume that she was an improved version of the original *Pioneer*, with a longer central cylinder. Although we know little about her propulsion system, McClintock claimed that "There was much time and money lost in efforts to build an electro-magnetic engine for propelling the boat." Certainly in December 1862, the Confederate Patent Office granted a patent to a New Orleans inventor who claimed to have produced "a machine for operating submarine batteries." This may well have been the flawed electro-magnetic propulsion system. If indeed this was fitted, it makes the *Pioneer II* a craft well ahead of its time, and explains why the designers encountered so many problems in her production. They then tried a high-pressure steam engine, which was probably designed to be shut off when the boat submerged, giving her engines a finite running time before the boilers cooled and the oxygen ran out. Even this proved too advanced, so that by the time the boat was ready for its first sea trials in January 1863, she was propelled by a hand-powered crank geared to the propeller. In February 1863 Admiral Buchanan, in command of the naval forces at Mobile, wrote to Secretary of the Navy Mallory, reporting that the submarine experiments had been a failure. He states that both the electrical and steam systems were deemed failures and were removed. Consequently the boat had a top speed of just 2mph, and at one stage the boat sank in the harbor, her crew almost drowning. He concluded: "I never entertained but one opinion as to the result of this boat, that it should prove a failure, and such has been the case."

Despite this, the testimony of a Confederate deserter suggests that the *Pioneer II* attempted to attack the Union fleet which was blockading Mobile. He stated that "An infernal machine, consisting of a submarine boat, propelled by a screw which is propelled by hand, capable of holding five persons, and having a torpedo which was to be attached to the bottom of a vessel, and exploded by means of clockwork" made a sortie on February 14, 1863, but was forced to turn back due to a strong

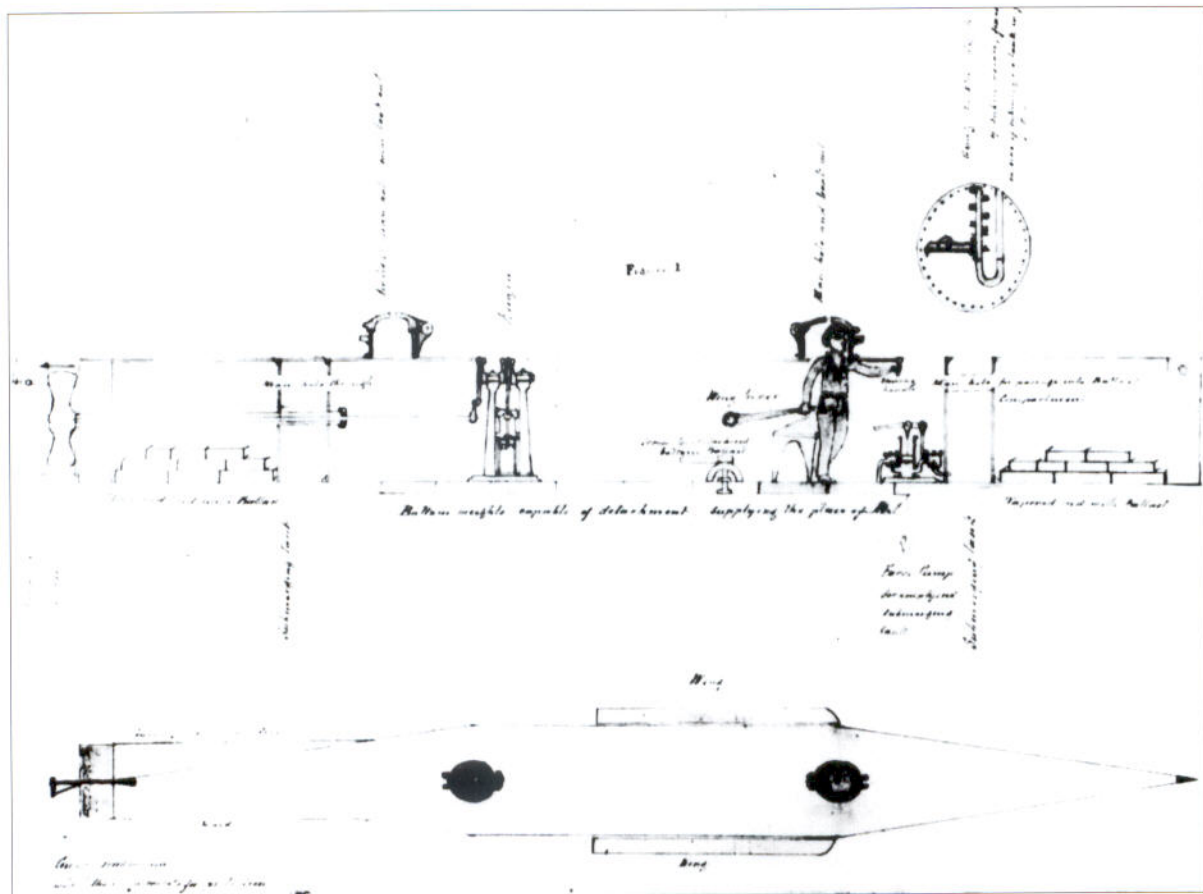

current, and had to cut her torpedo adrift. From this it appears that she towed her torpedo behind her, a method which was also mentioned by Admiral Buchanan. No other account of such an attack exists, so it can be assumed that the deserter was confused. We do know from postwar correspondence that the *Pioneer II* was lost in rough seas while being towed from Mobile to Fort Monroe, where she would be in a position to attack the Union fleet. What the deserter might have heard about was the towing boat cutting her towline and casting the submarine adrift, not the submarine casting loose her torpedo. McClintock states that no lives were lost in the sinking, which we can assume took place on February 14. The submarine still lies somewhere in Mobile Bay.

The construction of a new submarine was proposed, and this time McClintock, Watson, and Hunley would be joined by a new business partner. The Texan engineer Edgar C. Singer specialized in the development and production of torpedoes, and was currently in Mobile producing torpedoes in collaboration with a group of fellow Texans. After the *Pioneer II* debacle, the three submarine designers needed a backer, so they joined forces with Singer, forming the Singer Submersible Corp. Singer and Hunley each owned a third of the company, and the remaining stake was divided between three of Singer's Texan associates, who included "Gus" Whitney, the group's publicist. Hunley and Lieutenant Alexander supervised the production of the submarine, while McClintock and Watson played a major part in its design.

This is almost certainly a diagram of the *Pioneer II* (or *American Diver*), drawn from memory by James McClintock during a meeting with British submarine designers in Canada during 1872. (Public Record Office, London)

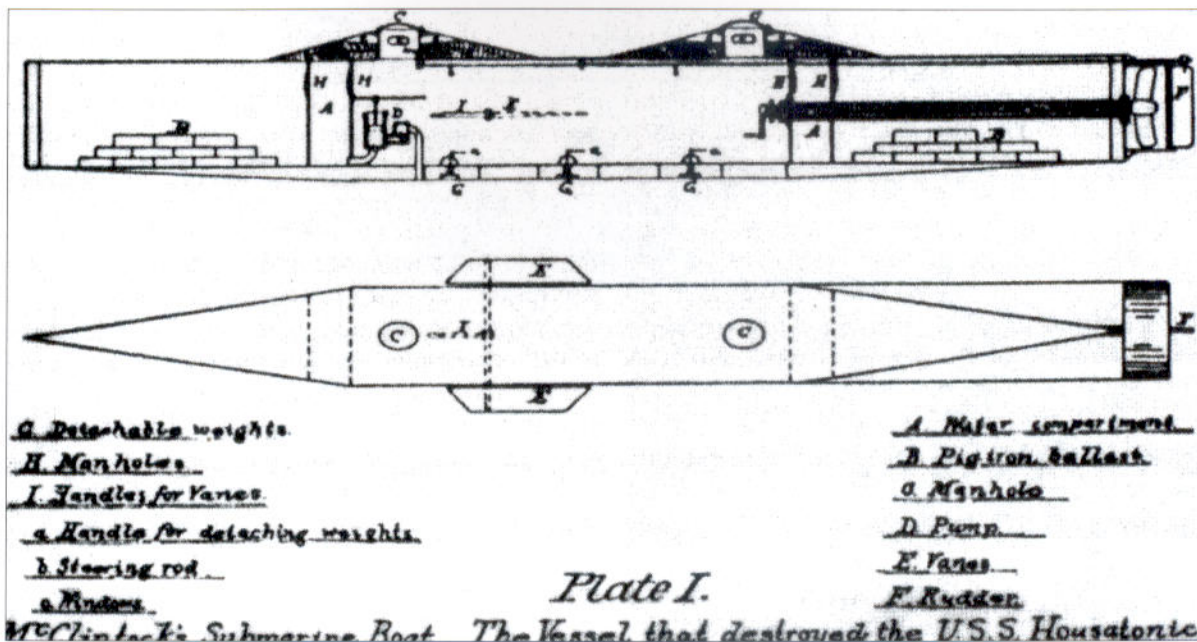

Although this diagram by James McClintock almost certainly represents the *Pioneer II*, she was confusingly labeled as "the vessel that destroyed the *Housatonic*." (Public Record Office, London)

Lieutenant Alexander described the new craft:

We decided to build another boat, and for this purpose took a cylinder boiler which we had on hand, 48in. in diameter, and 25ft long (all dimensions are from memory). We cut this boiler in two longitudinally and inserted two 12-in. boiler iron strips in her sides; lengthened her by one tapering course fore and aft, to which were attached bow and stern castings, making the boat about 30ft long, 4ft wide and 5ft deep. A longitudinal strip 12in. wide was riveted the full length on top.

He then described her ballast:

At each end a bulkhead was riveted across to form water ballast-tanks (unfortunately these were left open on top); they were used in raising and sinking the boat. In addition to these water tanks the boat was ballasted by flat castings, made to fit the outside bottom of the shell and fastened thereto by "Tee" headed bolts

A Singer torpedo fitted to a spar torpedo mount. Unlike the version fired by pulling a lanyard, this device had a contact ignition system, triggered by the fuse shown beside the casing. This was the type used by the *H.L. Hunley* when she attacked the *Housatonic*. (National Archives)

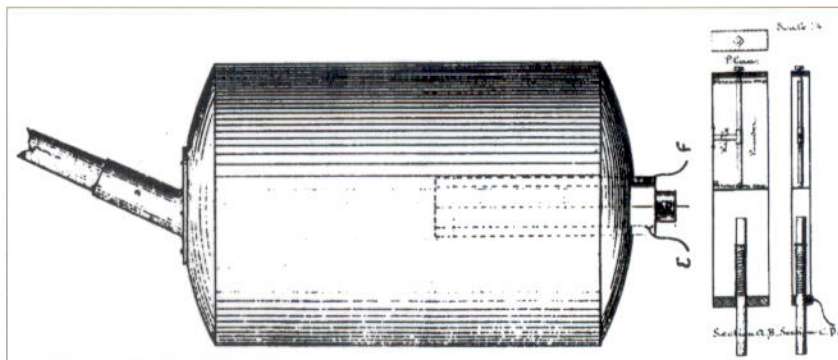

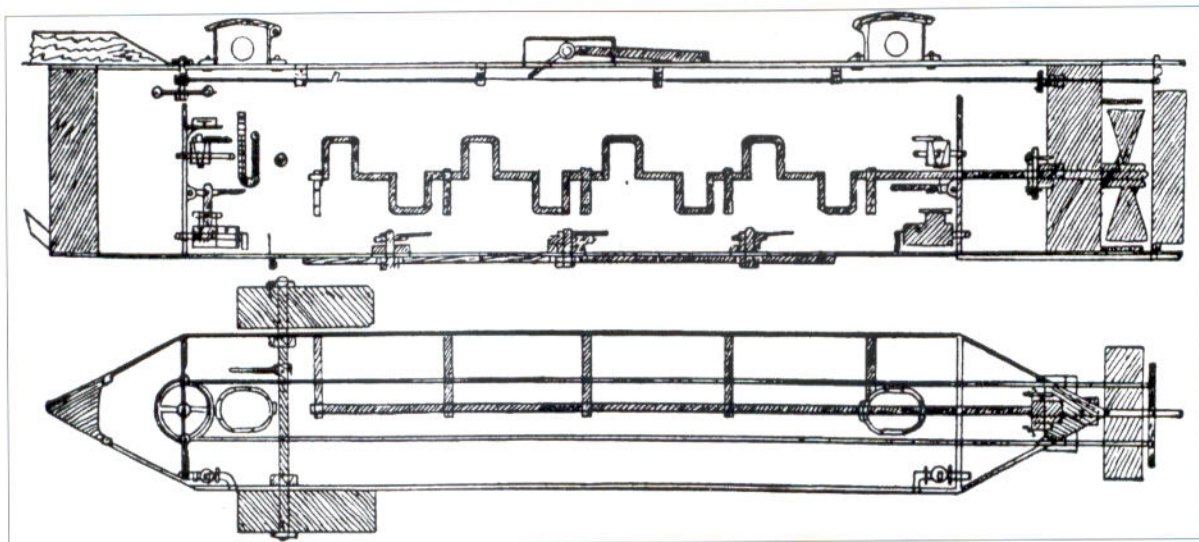

passing through stuffing boxes inside the boat, the inside end of the bolt squared to fit a wrench, that the bolts might be turned and the ballast dropped should the necessity arise. In connection with each of the water tanks, there was a sea cock open to the sea to supply the tank for sinking; also a force pump to eject the water from the tanks into the sea for raising the boat to the surface.

It was a simple but effective system. A mercury gauge attached to the forward tank served as a depth gauge.

Alexander went on to describe the rudders and fins used to steer the craft. Fins were attached to a shaft which passed through two stuffing boxes and pierced the hull. These lateral fins (5ft long and 8in. wide) and their connecting shaft were "operated by a lever amidships, and by raising or lowering the ends of these fins, operated as the fins of a fish, changing the depth of the boat below the surface at will, without disturbing the water level in the ballast tanks."

The boat was powered by eight hand-crankes, set in a central rod and all set at different angles. The rod was supported by brackets on the starboard side of the boat, while the crew sat on the port side and turned the cranks. He also noted that once everyone was in place, it was very difficult to move, and that the propeller sat inside a metal band designed to reduce the risk of fouling. Alexander went on to describe the boat's two hatches, stating that four men exited from each hatch, and that they were sealed with rubber gaskets, and screwed shut from the inside. Combing glass provided some means of looking out without opening the hatches, while an air box set in the top of the boat allowed fresh air to enter the craft when opened, even though she was under way and the hatches were closed. Her designers had learned their lessons from their previous boats, and this new craft represented a culmination of two years of trial and error. The result was a crude but fully operational submarine. This claustrophobic metal tube was duly christened the *H.L. Hunley*, in honor of her financial backer and advocate, even though by this stage Hunley spent most of his time seeing to other military ventures in Mississippi.

A cutaway view of the *H.L. Hunley*, drawn from memory by Lieutenant William A. Alexander, who played a major part in her construction in Mobile. A comparison with the archaeological evidence suggests Alexander was surprisingly accurate in most details. (US Naval Historical Center, Washington, DC)

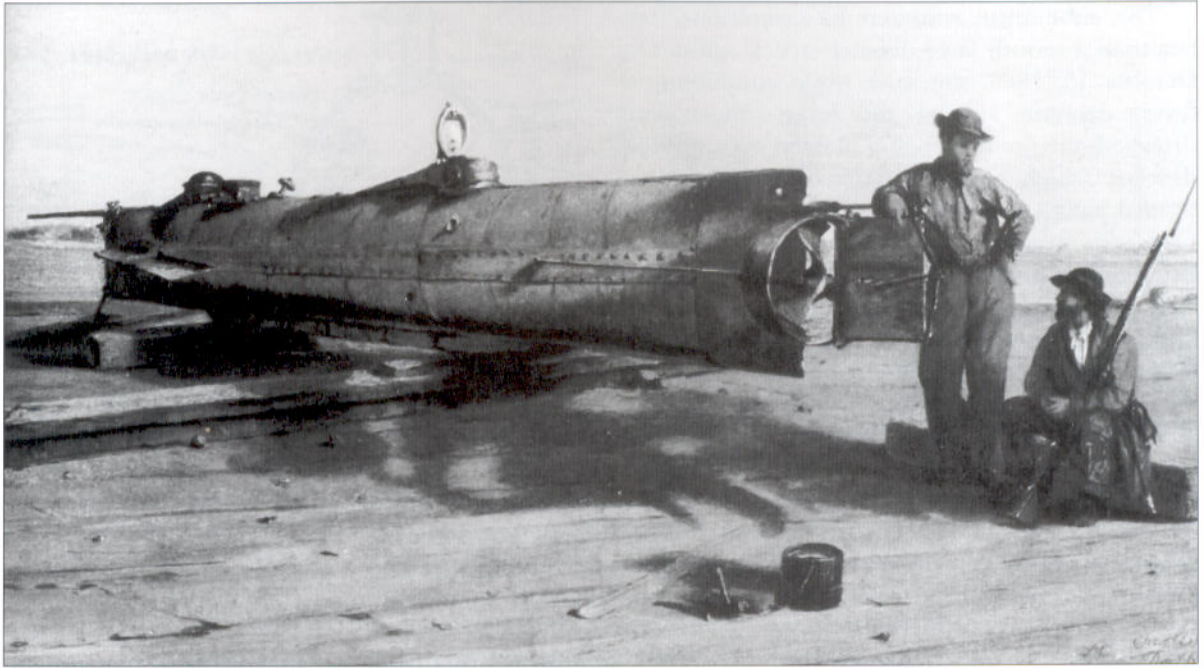

Submarine torpedo boat *H.L. Hunley*, December 6, 1863. Watercolor by Conrad Wise Chapman. (Museum of the Confederacy, Richmond, Virginia)

In July 1863, the *H.L. Hunley* was launched and her sea trials began. Her commander at the time was probably either McClintock or Lieutenant George E. Dixon, an engineer from Kentucky who had served as an officer in Lieutenant Alexander's old regiment, the 21st Alabama Volunteers. Dixon fought at Shiloh in April 1862, and apparently his life was spared when a bullet struck him in the leg, only to be deflected by a \$20 gold coin in his pants pocket, a present from his girlfriend. After that he carried the buckled coin in his pants pocket as a good luck charm. After the battle he was sent to Mobile to recover from his leg wound, where his engineering background brought him into contact with the submariners. He clearly showed a profound interest in the project, as by the time of her launch he had become closely involved with the submarine. He went on to command her at Charleston. Two weeks after her launch the boat demonstrated her effectiveness to Admiral Buchanan by towing a torpedo which destroyed an anchored coal barge. This time the old naval officer was impressed, and he recommended "the invention of Messrs. Whitney and McClintock" to General P. G. T. Beauregard in Charleston. The general proved a willing convert who saw the potential of the vessel, and within a fortnight the *H.L. Hunley* was being unloaded from a railroad car at Charleston and transported to an inlet near Sullivan's Island.

Feeling her engineer crew lacked the necessary experience or even willingness to lead the *H.L. Hunley* into action, the boat was seized by the Confederate authorities, who then handed her over to a raw naval crew, commanded by Lieutenant John A. Payne. On August 30, she sank while alongside the dock, as Payne accidentally stepped on her dive plane lever and the boat went down, allowing water to flood into her hatches. Five of her crew drowned, although Payne survived the disaster. She was duly raised and the crew exhumed. A new crew were recruited by Hunley, this time from the machine shop in Mobile, and the *H.L. Hunley* was back in service within three weeks.

The submarine resumed its operations, but less than a month later disaster struck again. On October 15, 1863, she sank while conducting a diving exercise. Hunley and seven others were drowned, the accident being blamed on a sudden descent which caused water from the open-topped ballast tanks to fill the compartment. The boat was eventually salvaged, her second crew exhumed, and she returned to service. This time her commander would be Lieutenant Dixon. Only the desperate situation facing Charleston led General Beauregard to sanction the continuation of submarine operations, despite his reservations. Somehow volunteers were found for another crew, and Dixon made preparations to attack the Union fleet, choosing the USS *Housatonic* as his target. This, the *H.L. Hunley*'s first operational mission, was also her last. On February 17, 1864, she sortied to attack the *Housatonic*. Although the Union warship was destroyed, the *H.L. Hunley* never returned from the mission.

In May 1995, an expedition funded by novelist Clive Cussler located the *H.L. Hunley* four miles off Sullivan's Island. She was lying on her starboard side in five fathoms (30ft), and her bows were pointing toward her base in Breach Inlet when she went down. Several charitable and federal bodies joined forces to undertake the archaeological excavation and recovery of the vessel, and these efforts culminated in her raising in August 2000. The *H.L. Hunley* was transported to a purpose-built Conservation Center, where a team of archaeologists and conservators began the painstaking task of recording, examining, and preserving her and all artifacts associated with the wreck. Naturally the boat was also a grave, as she contained the bodies of Dixon and his crew. During April and May 2001, the bodies were located and removed. On April 17, 2004, these men were buried with full military honors in Charleston, next to the graves of her previous two crews. The archaeological work is still continuing, but it has already provided us with a wealth of new information on Civil War submarines and how they worked. However, one of the most poignant finds was not part of the boat itself. In May 2001, a buckled gold coin was found in the mud which had filled the *H.L. Hunley*. Its inscription proved beyond doubt that it was Lieutenant Dixon's lucky gold coin.

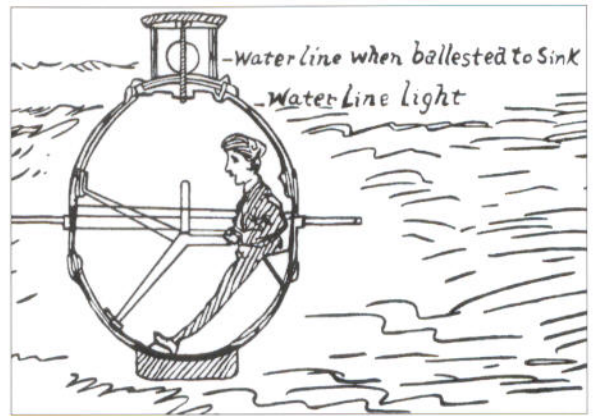

A cross section of the *H.L. Hunley*, drawn from memory by Lieutenant William A. Alexander. If anything, it fails to capture the incredibly cramped conditions inside her hull. (US Naval Historical Center, Washington, DC)

Late-war torpedo boats

In addition to the Confederate torpedo boats built in Charleston and Richmond, a handful of other surface torpedo boats were built by both sides during the final years of the war.

Perhaps the most successful of these was the USS *Stromboli*, designed by William W. Wood, and built in record time at the Pook Ironworks on the Mystic River, Connecticut. She displaced 116 tons (207 tons fully laden), and was 84ft 2in. long, with a beam of 20ft 8in. and a draft of 7ft 5in. She was powered by a single high-pressure steam engine which operated a single screw, giving her a top speed of around 5 knots. Commissioned in October 1864, she was renamed the USS *Spuyten Duyvil* a month later. She was a wooden vessel with an extremely low

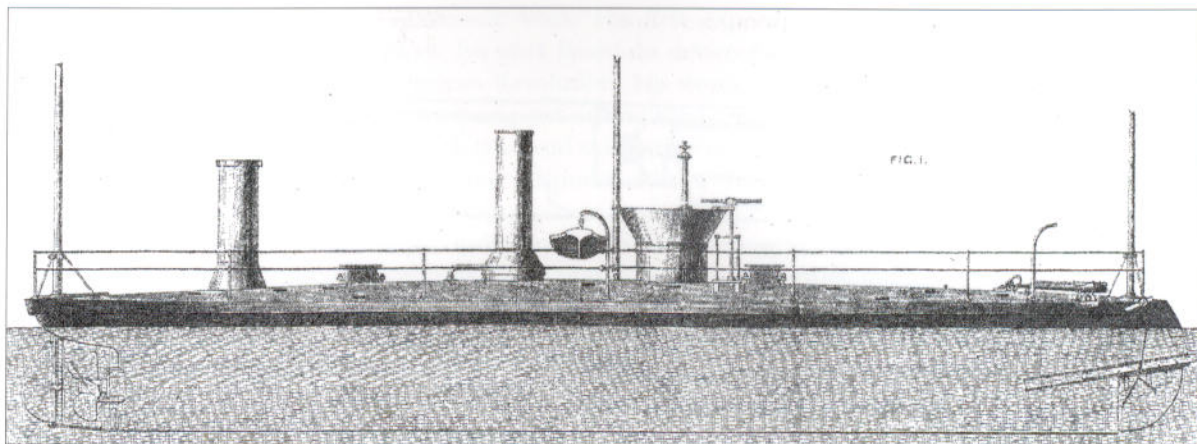

The USS *Spuyten Duyvil* looked like a small monitor, but she was actually a purpose-built and revolutionary type of torpedo boat. In this depiction of her, the artist has incorrectly shown her spar torpedo mechanism pointing upward. The correct angle is shown below the cutaway side elevation of the vessel. (US Naval Historical Center, Washington, DC)

BELOW A cutaway view of the bow of the USS *Spuyten Duyvil*, showing the mechanism used to deploy or retract the spar torpedo. A chamber in the bow was flooded before the torpedo was deployed. Note the small hinged cutwater in the vessel's bow, one of two which could be raised out of the way when the spar torpedo was deployed. (Stratford Archive)

freeboard. A circular conning tower was sited amidships, while behind it a smokestack and a tall air intake protruded from her deck, giving her the appearance of a small monitor. She was armed with an ingenious retractable spar torpedo, which was deployed from a hatch in her bow below the waterline by means of a pulley system. Although this proved slow and cumbersome, this experimental vessel was deemed a success, and served with distinction on the James River, participating in the Battle of Trent's Reach in January 1865.

While five Union tugs (*Alpha*, *Belle*, *Delta*, *Gamma*, *Hoyt*, and *Martin*) were converted to carry spar torpedoes during 1864 (a group known as the Alpha Class), none saw service in their original role, apart from the tug *Alpha*, which was redesignated Picket Launch No. 1. Under the command of Lieutenant William B. Cushing she attacked and sank the Confederate ironclad CSS *Albatross* on October 28, 1864. The remaining vessels of the class were used as gunboats, the majority serving on the James River. Similarly, while contracts were signed to produce two more experimental spar torpedo vessels, these were not completed until 1874, some nine years after the war ended. The USS *Alarm* and the USS *Intrepid* were both over 170ft long, and powered by twin compound engines which gave them a top speed of over ten knots. Neither proved successful, and they were both decommissioned in the 1890s.

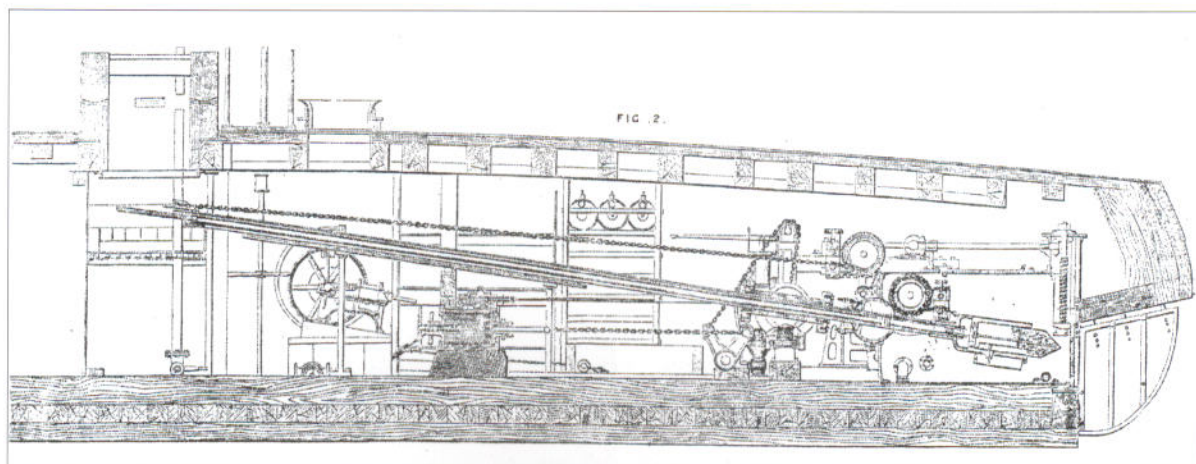

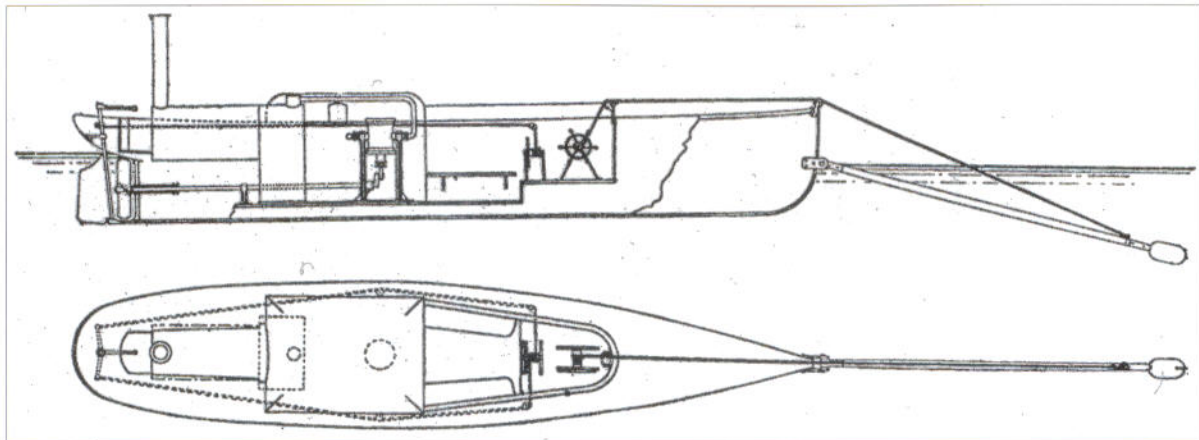

In early 1864, the Confederate Navy commissioned the construction of a series of spar torpedo boats designed by Naval Constructor William A. Graves, to be built in yards across the country – four in Richmond, Virginia, two in Columbus, Georgia, and one on South Carolina's Pee Dee River. Graves' torpedo boat design called for a vessel with a powerful single-screw propulsion system, 50ft long, with a 6ft beam and a 4ft 6in. draft. The British-built engines were to be brought into the Confederacy by blockade runners, but they were never shipped before the war ended. In the end the only Graves Class torpedo boat to be completed was the *CSS Viper*, built at Columbus, and powered by a local engine. She was abandoned before she could enter service. Finally, there was the small *CSS General Whiting*, the only one delivered of several British-built steam-powered torpedo boats which had been ordered by the Confederacy during the summer of 1864. She was delivered in Wilmington by a blockade runner during September 1864, but there is no record she ever saw service. During the last months of the war it is possible that other Confederate torpedo boats were being built, but the end of the war came before they could attack the enemy.

OPERATION

The torpedo

The development of submarines and torpedo craft in Confederate service came about because of the development of the spar torpedo. This weapon consisted of a cased charge attached to the end of a spar extending in front of the bow of a vessel. This spar was usually hinged so it could be swung out of the way when not in use. The charge consisted of anywhere from 50lb to 150lb of explosives, and was usually detonated by means of a pressure-sensitive fuze. In other words, someone had to ram the charge into the side of an enemy warship before it exploded. The initial idea for a boat-mounted explosive charge of this kind has been attributed to Pennsylvania-born Robert Fulton, who developed the system in 1810, at the height of the

A depiction of the *CSS Squib*, which was a similar vessel to the Union Alpha Class tugboat which attacked and sank the ironclad *CSS Albemarle* in October 1864. The spar boom could be raised into a vertical position when not deployed for action. (US Naval Historical Center, Washington DC)

BELOW Lieutenant Cushing in *Pickett Launch No. 1* (formerly the tug *USS Alpha*) attacked and sank the ironclad *CSS Albemarle* while it lay at anchor in North Carolina's Roanoke River on the evening of October 28, 1864. Although the ironclad was protected from drifting torpedoes by a floating boom, the spar torpedo was able to clear the boom and strike the side of the Confederate warship. (Stratford Archive)

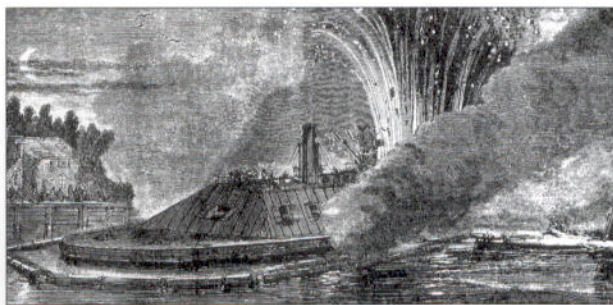

Napoleonic Wars. His first experiments had been with static moored mines, his work based on devices built by American engineers during the American Revolution. His development of an offensive mine resulted in the weapon used during the Civil War.

Both land and submarine mines were used extensively during the Civil War. These weapons had two distinct roles: first as a defensive means of controlling access to a waterways and impeding the movements of enemy ships, and secondly as an offensive measure used against fortified land positions. The latter role developed from the siege operations of earlier wars, which involved the digging of a tunnel or "mine" under an enemy position, then using the tunnel to place an explosive charge under the enemy works. A prime example of this was the mine explosion during the siege of Petersburg in July 1864, when 8,000lb of explosives were detonated beneath Confederate defenses (the incident was depicted in the film *Cold Mountain*). For some reason, the use of defensive mines on land was never fully developed during the conflict, and the term "mine" later became associated with its maritime counterpart, which was more accurately called a "torpedo," at least until after the end of the Civil War.

Mine warfare at sea has a history stretching back to the American Revolution, when attempts were made to place underwater explosive

A selection of different types of spar torpedoes were used, and these were detonated by a range of ignition devices, from lanyard-operated friction primers to contact detonation devices and even clockwork timers. (Stratford Archive)

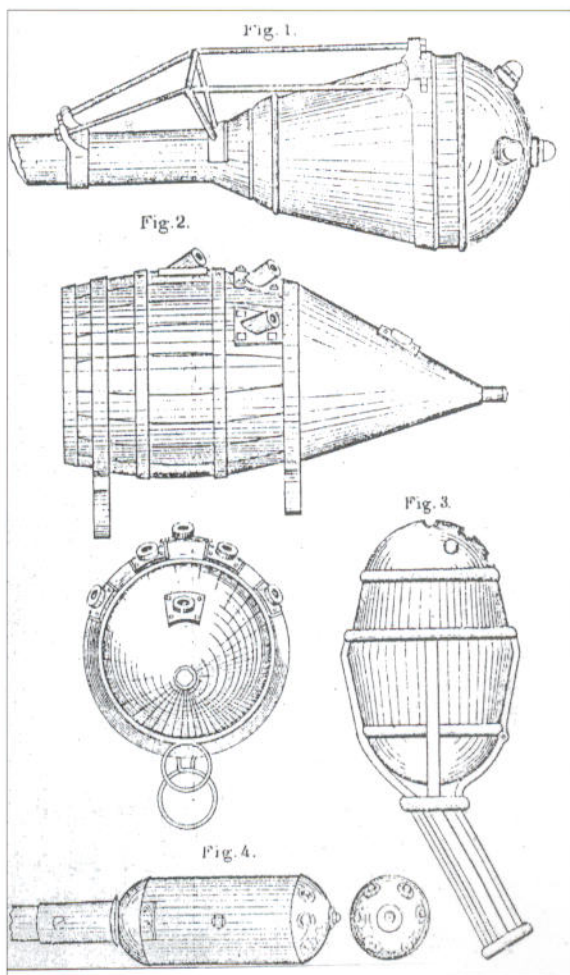

charges against British warships. These early "torpedoes" were designed to be fired using clockwork trigger mechanisms, or by hand-operated lanyards operated from a boat or the shore. The next significant advance came as a result of the work of British scientist Michael Faraday (1791–1867) on electrical current. It became possible to sink a torpedo underwater, then explode it by means of an electrical charge triggered from the shore and passed along a wire. This meant that torpedoes could be laid defensively, and exploded when an enemy warship passed over them days, weeks, or months later.

Soon it became usual for observers in shore batteries to control the torpedo "minefields" laid across harbor entrances, allowing friendly ships to pass safely, but detonating torpedoes when enemy ships tried to force a passage through the minefield. The one drawback of this method was that through corrosion or a faulty connection the torpedo would not always explode at the critical moment. An electrically detonated torpedo might have destroyed the powerful ironclad USS *New Ironsides* off Charleston Harbor in April 1863, but the electrical cable linking the torpedo to the shore had been accidentally severed by a passing wagon, and the device never detonated. Electricity was still a largely unknown force in this period, and although waterproofed insulated cable had already been invented, reliability problems continued to plague these weapons. It was not until after the Civil War that electrically operated mines would come into their own.

A more reliable method was the torpedo designed to detonate on contact, the forerunner of the mines used in their thousands during the 20th century. The introduction of crude percussion-type fuzes during the years immediately preceding the Civil War meant that this technology was widely available to both sides. French engineers first developed these weapons during the Crimean War (1854–56), but they would be first put to the test during the Civil War. There were two main methods of using contact torpedoes. They could either be laid in defensive “minefields” to block harbors or rivers, or they could be used offensively by mounting the explosive devices on specially converted boats or even submarines. This latter use of contact torpedoes is the main focus of this book, although both offensive and defensive torpedoes went on to have a profound influence on naval strategy and tactics from the Civil War onward.

Following the outbreak of the Civil War in April 1861, it became apparent that the Confederacy would need to develop new ways of defending her coastline, given the numerical superiority of the Union fleet which had begun to blockade her harbors. Secretary of the Navy Stephen Mallory approved the patent and design of several torpedo types, and one of the first of these was discovered in the Potomac River off the Washington Navy Yard in July 1861, just three months after the war began. The sailors who found it defuzed this “infernal machine” before it could cause any damage. This early device was little more than a coiled and burning 40ft-long fuse sitting on top of two explosive containers, but later torpedoes were more sophisticated. Mallory sanctioned their widespread use as an adjunct to the static defenses of Southern harbors, and during the war the Confederacy became increasingly reliant on torpedoes as a means of counteracting Union numbers.

The later, more sophisticated torpedoes employed percussion detonation devices and friction types. The problem of making sure the

A Confederate vessel laying torpedoes in Charleston Harbor under cover of darkness. Specially converted harbor vessels were often used; in this case a barge rigged with a lifting gantry, which would have been towed into position by the waiting sidewheel tugboat. (Stratford Archive)

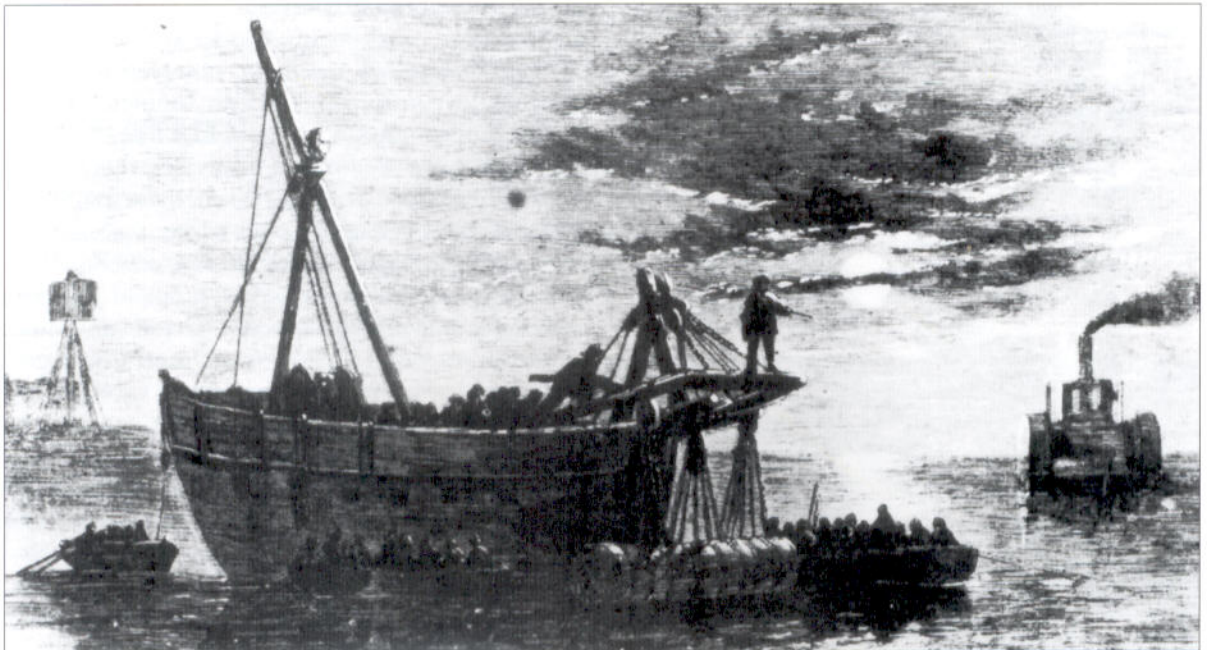

torpedo detonated when a ship came into contact with it proved a challenge to designers, who found several ways to solve the problem, not all of which were effective. In the South, one of the most famous torpedo designers was Commander Matthew Fontaine Maury (1806–73), a leading expert on oceanography and maritime geography who resigned his US Naval commission when his native Virginia seceded from the Union. Although he served on diplomatic missions abroad during the war, and was responsible for the design of a class of gunboats, he first served in Richmond as the Secretary of the Navy's advisor on torpedoes.

Officially the Confederacy's torpedo warfare program was the responsibility of the Office of Ordnance and Hydrography (founded in March 1861), but in effect it operated as an independent department in its own right. In August 1861, Maury was named as head of the "Submarine Battery Service," a section which officially oversaw the development of electrically detonated torpedoes as part of a comprehensive program of harbor defense improvement. In practice he was the Confederacy's mine "supremo," and he helped develop a series of torpedoes, including some of the first spar torpedo plans. When he left for Europe in the late summer of 1862, he was succeeded by Lieutenant Hunter Davidson, formerly the commander of the gunboat CSS *Teaser*. It was Davidson who supervised the subsequent development of the torpedo, and was responsible for most later technical developments in Confederate torpedo designs.

In October 1862, the Torpedo Bureau was created under the leadership of a seasoned field officer, Brigadier-General Gabriel J. Rains. The general had already employed similar devices on land; booby-trapped and half-buried shells rigged with primers which were designed to explode when stepped on. He used them to good effect at Yorktown in May 1862, despite the outrage with which their use was met in Northern newspapers. Rains worked with engineers and technicians to improve torpedo designs, and established torpedo stations in Richmond, Wilmington, Charleston, Savannah, and Mobile, as well as smaller stations in other locations. The result was the deployment of increasingly sophisticated mines around the coast and in the rivers of the Confederacy, and a growing reliance on torpedoes as a means of countering Union numerical superiority.

Other leading Confederate torpedo designers included Beverly Kennon (who built the Potomac torpedo), and Isaac N. Brown (who won fame as commander of the CSS *Arkansas*), although it was the Texan E. G. Singer who developed the torpedo which would eventually be used on Confederate torpedo boats and submarines. Singer's device used a unique spring-action ignition system which was relatively foolproof, and several variants of this ignition system were produced in his homegrown workshop in Lavaca, Texas, or produced elsewhere under Singer's patent. Unlike a pure contact torpedo, this device could be driven against an enemy hull, then exploded at the appropriate moment by

Commander Hunter Davidson commanded the Naval Submarine Torpedo Battery (part of the Torpedo Bureau) from the summer of 1862 onward, and in April 1864 he commanded the CSS *Squib* during her attack on the USS *Minnesota*. (US Naval Historical Center, Washington, DC)



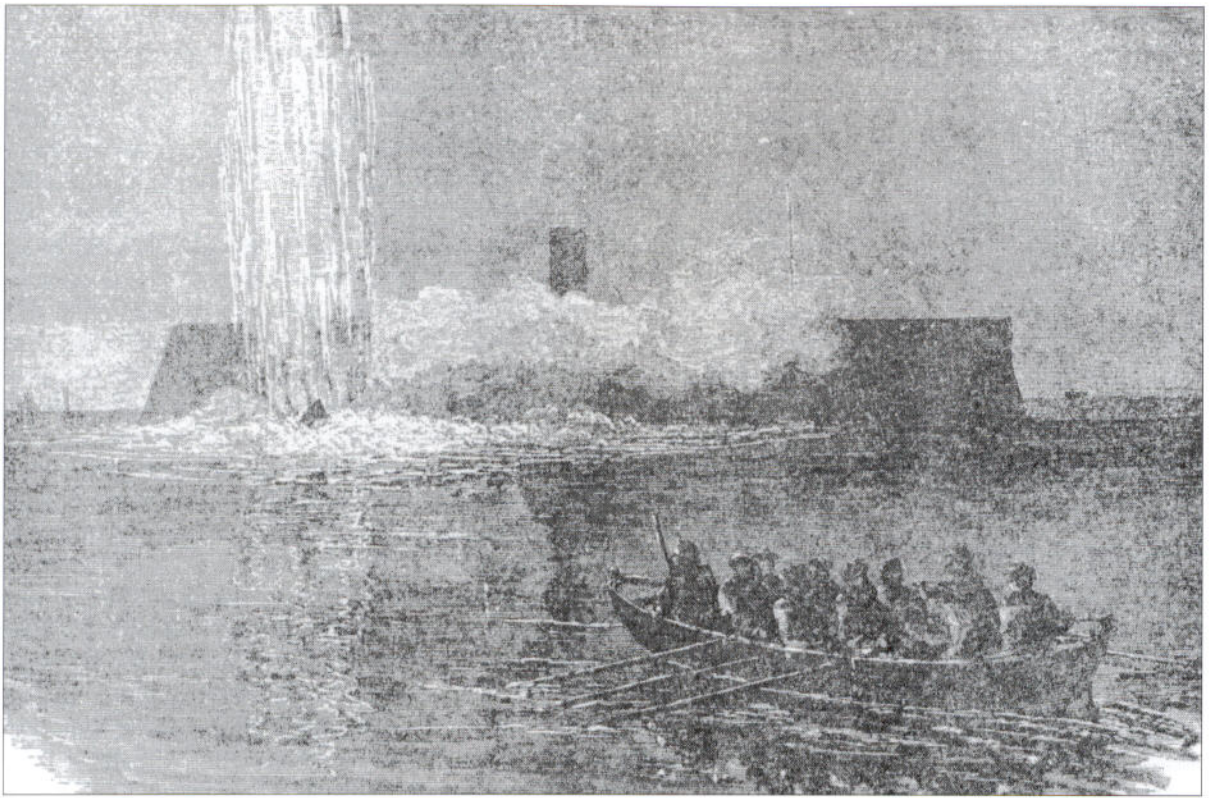

means of a lanyard pulled by a sailor on board the attacking craft. An obvious advantage of this was that it allowed the device to be positioned with more accuracy, or moved down an enemy hull until it was in the ideal position. It first entered service in February 1863, and the following month it was used as part of an experiment which helped transform torpedoes from a defensive weapon into an offensive one. The device was later developed by Singer working in conjunction with the staff of the Torpedo Bureau, and the result was the weapon which destroyed the USS *Housatonic* in February 1864.

As well as finding means to use torpedoes defensively, both Union and Confederate naval officers and engineers devised techniques to turn the contact torpedo into an offensive weapon. As we have seen, on March 13, 1863, Captain Francis D. Lee used a spar torpedo mounted on a 20ft oared longboat to destroy a hulk moored in Charleston Harbor. The device worked, so the Confederates looked around for ways to use the same weapon against the enemy. The result was the introduction of the torpedo boat and the spar torpedo-armed submersible.

After its first use, the psychological impact of the new weapon proved almost as important as its physical influence. The blockading warships were now vulnerable to a new type of attack, raising the possibility that the Confederates might have found a way of breaking the Union blockade. To counter this new threat, Union commanders developed "anti-torpedo" measures, which included the deployment of picket boats, booms, anti-submarine nets, and even primitive minesweepers. However, the advantage remained with the attacker, and at night a small half-submerged boat equipped with a spar torpedo could easily sneak up

A fanciful depiction of either Captain James Carlin's abortive attack on the USS *New Ironsides*, August 21, 1863, or Lieutenant William T. Glassell's attack on the same target on October 5. If the former was depicted, the craft never fired off her torpedo, and if the scene depicts Glassell's attack, then no supporting boat was present. (Stratford Archives)

A: Torpedo boat CSS *David*

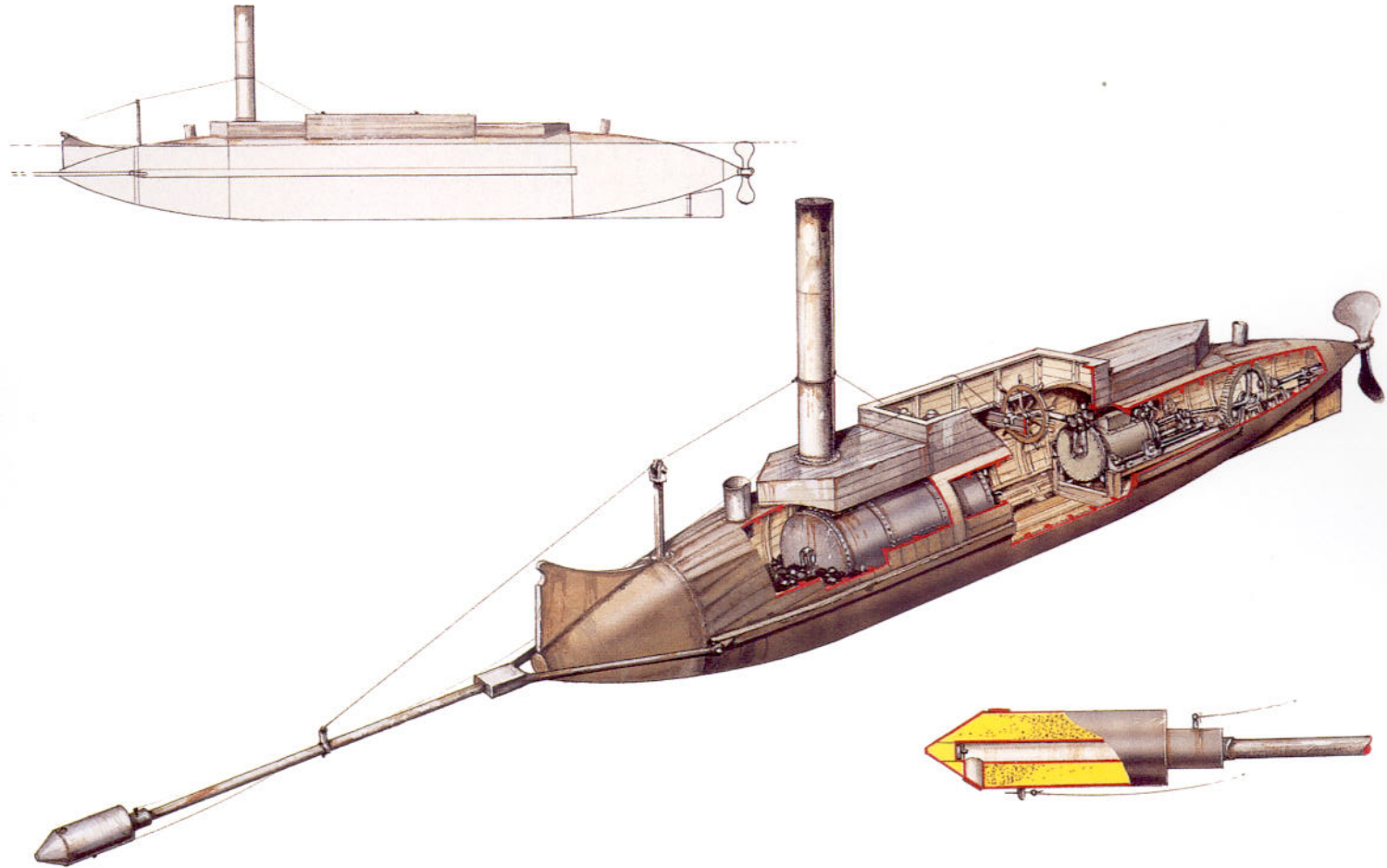

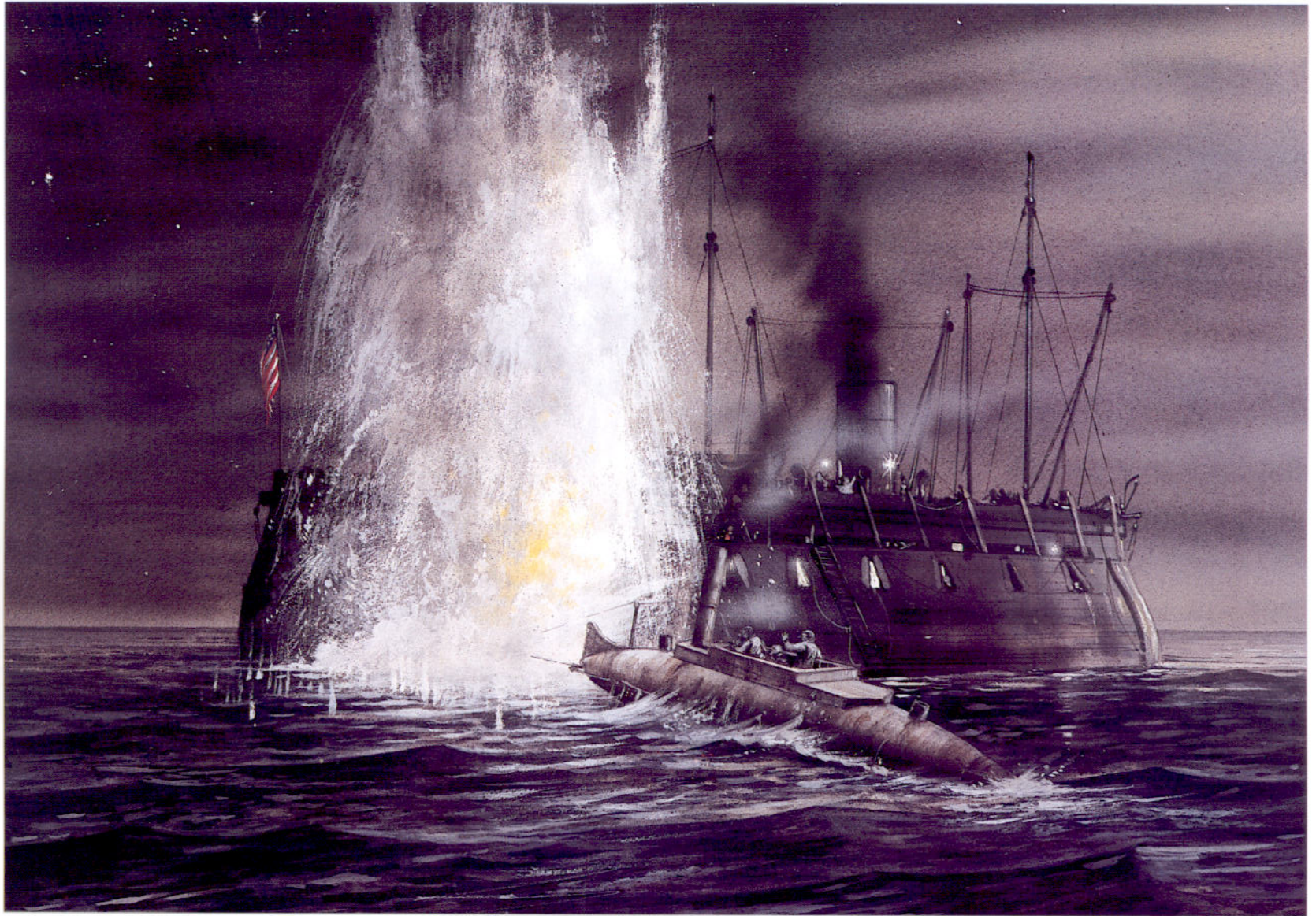

B: CSS *David* attacking USS *New Ironsides*, Charleston Harbor, October 1863

C: Torpedo boat USS *Spuyten Duyvil*

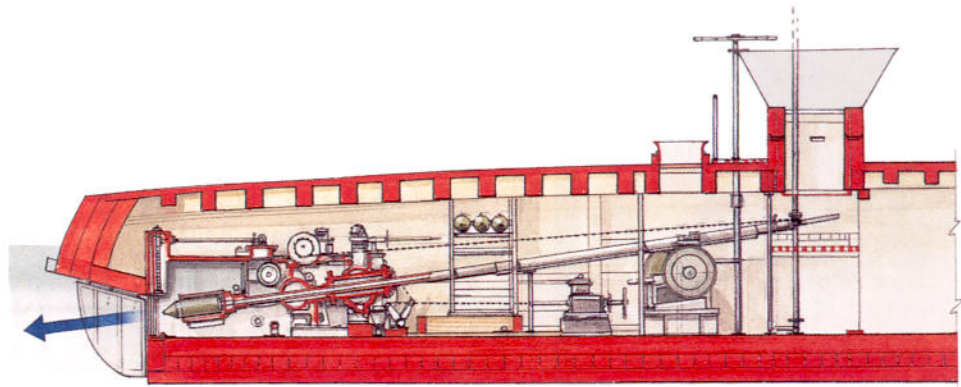
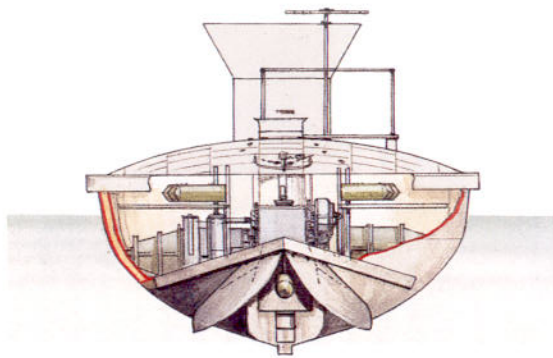
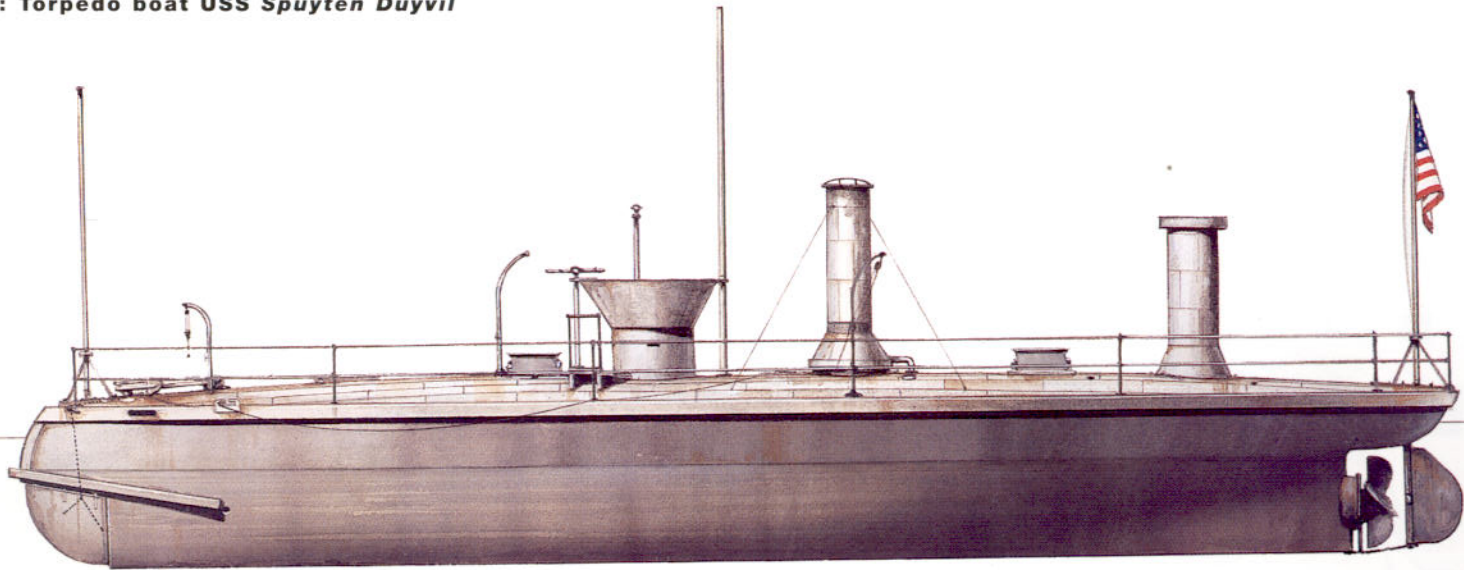

D: SUBMARINE CSS *H.L. HUNLEY*

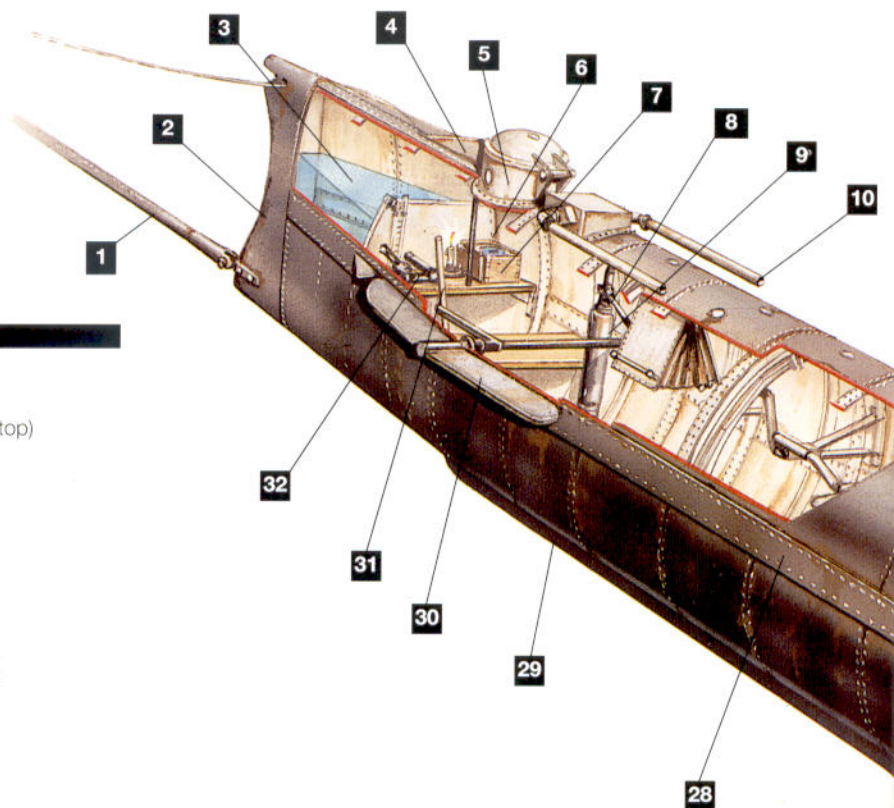

KEY

- 1 Spar torpedo boom coupling
- 2 Forward cast-iron section
- 3 Forward ballast tank (open at top)
- 4 Cutwater
- 5 Forward hatch
- 6 Commander's station
- 7 Compass box and candle
- 8 Air bellows
- 9 Ballast tank pump
- 10 "Snorkel" air tube
- 11 Deadlight (one of five per side)
- 12 Vision port
- 13 After hatch
- 14 Propeller cranks
- 15 Propeller shaft flywheel
- 16 Rudder connection
- 17 After ballast tank (open at top)
- 18 Cast-iron after-section
- 19 Rudder pivot bar
- 20 Rudder linkage mechanism
- 21 Rudder
- 22 Propeller
- 23 Rudder pivot running slot
- 24 Chain steerage connector gear
- 25 Ballast in removable keel
- 26 Ballast release bolt (one of three)
- 27 Crew seating
- 28 12-in. strake joining upper and lower sections of the hull
- 29 Central hull section
- 30 Diving planes
- 31 Sea Cock
- 32 Tiller
- 33 Gunpowder charge
- 34 Percussion cap
- 35 Spring-loaded firing pin
- 36 Lanyard

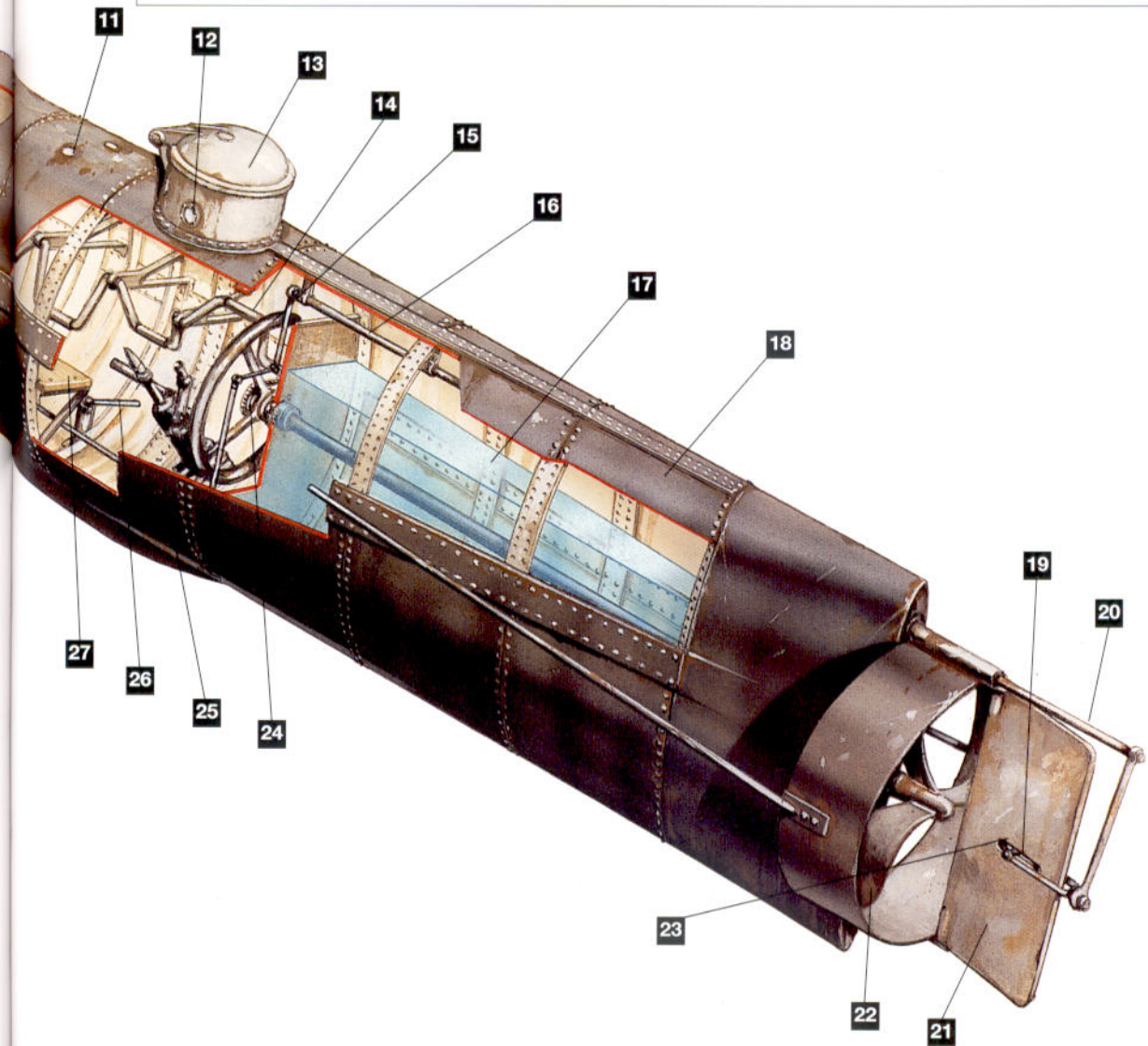
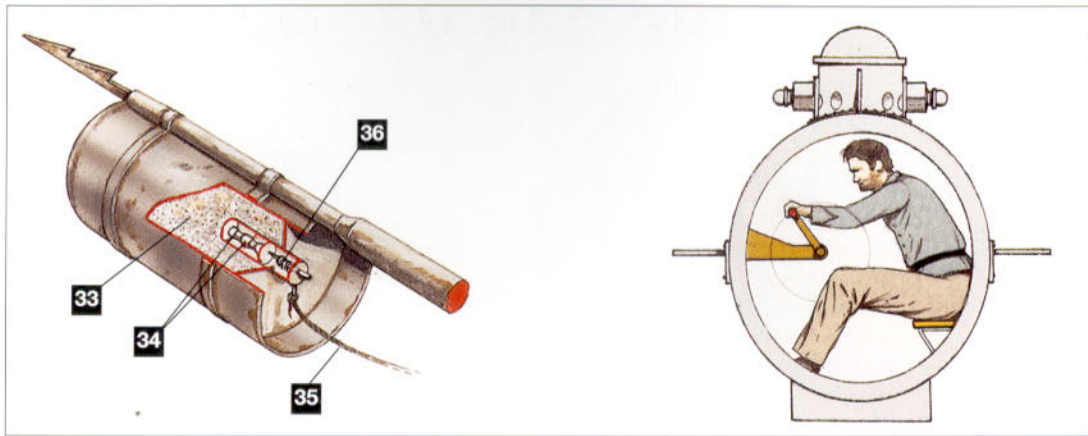

E: Submarines *CSS Pioneer*, *CSS Pioneer II* and *USS Alligator*

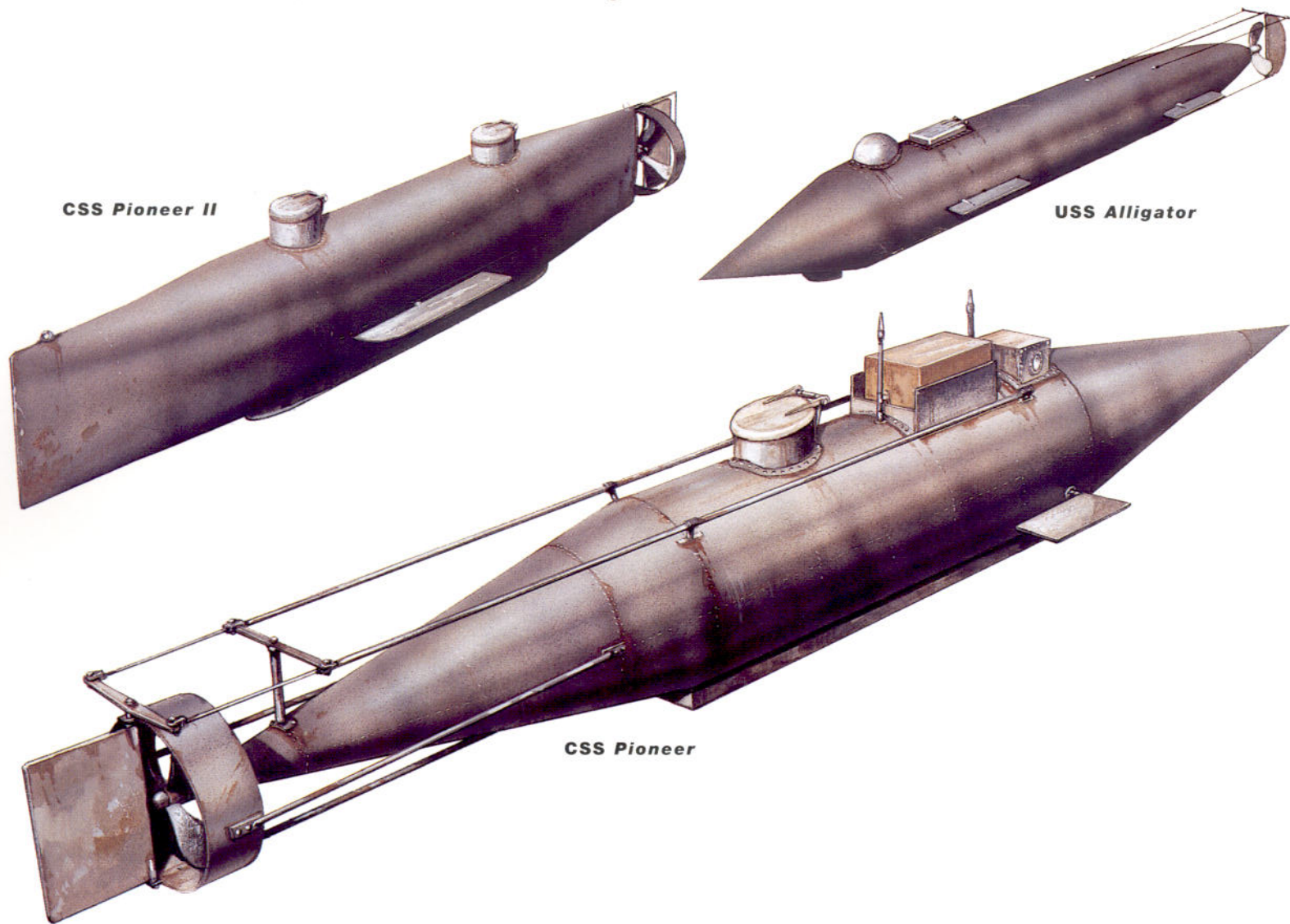



F: CSS *H.L. Hunley* attacking USS *Housatonic*, Charleston Harbor, February 1864

G: Torpedo boats CSS Squib and CSS Midge

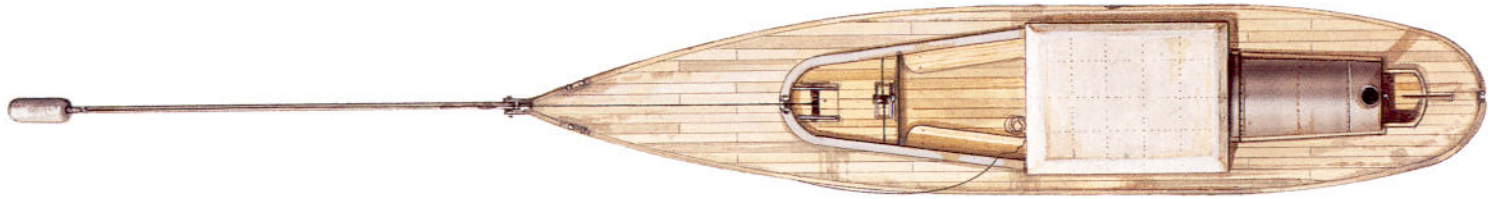

CSS Squib

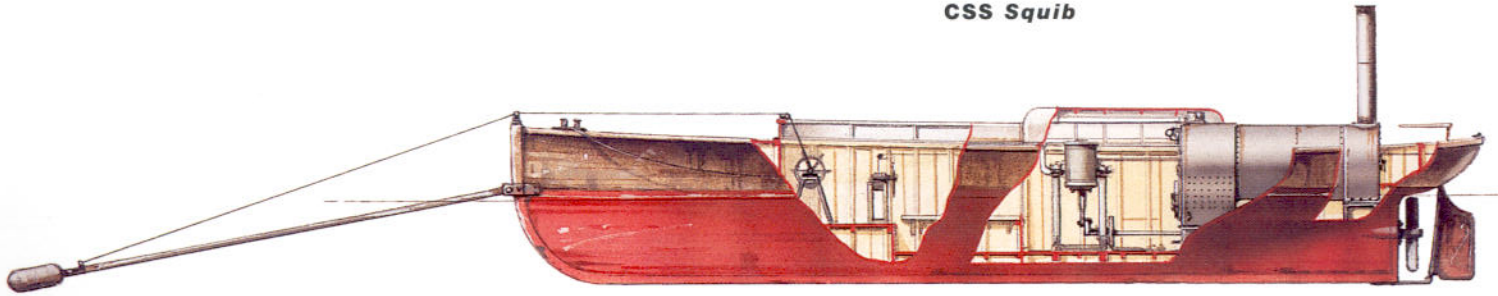

CSS Midge

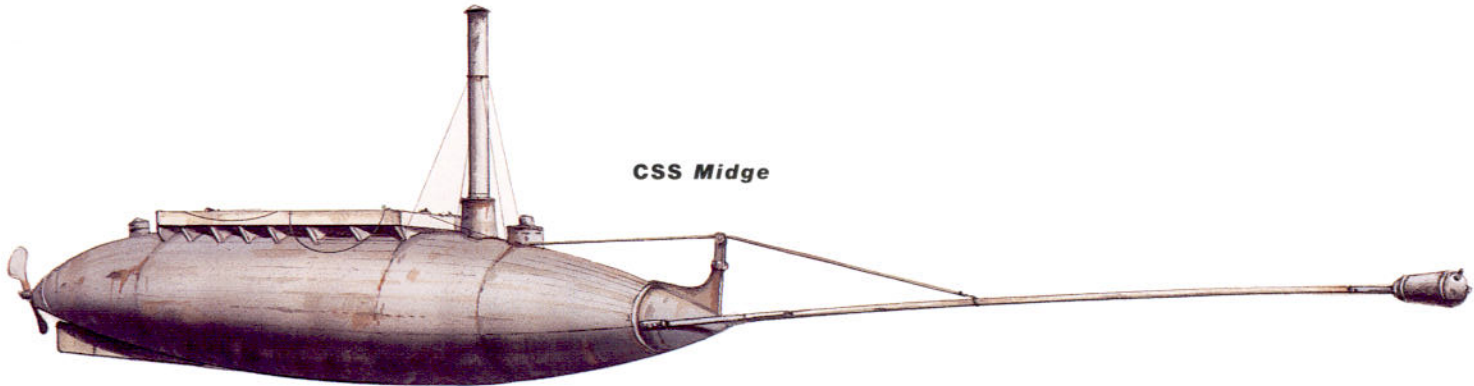

to an enemy without being detected. The US Navy also found ways to use spar torpedoes to their own advantage. During the last years of the war, a spar torpedo boat was developed, and a series of less successful ironclad spar torpedo vessels were designed, although it was found that they were worse than useless. More effective was the small steam-powered picket boat commanded by Lieutenant William Cushing which attacked and sank the Confederate ironclad CSS *Albatross* in the Roanoke River, North Carolina, in late October 1864.

Torpedo boats in action

After Captain Francis D. Lee demonstrated the effectiveness of the spar torpedo off Charleston in March 1863, the Confederates looked around for an enemy vessel to try their new weapon on. Although by this stage of the war the Union blockading fleet of Charleston included several ironclads, the most powerful Union warship was the flagship of the blockading squadron, the broadside ironclad USS *New Ironsides*. For the moment the ironclad was too far away to attack, so in the interim another target had to be found. Under the command of Lieutenant William T. Glassell, Lee's torpedo boat made an unsuccessful attack against the screw sloop USS *Powhatan* off Charleston a few days after Lee's demonstration; the helmsman panicked and swerved away from the target at the last minute. Despite this failure, the goal of attacking the *New Ironsides* remained uppermost in the minds of Lee, Glassell, and their fellow torpedo boat enthusiasts. Incidentally, another advocate of the offensive use of the torpedo was General P. G. T. Beauregard. He authorized the conversion of several more rowing boats to carry Lee's spar torpedo, so that by the late summer the Confederates had a small flotilla of boats at their disposal.

Another attack was postponed due to a Union naval offensive (Admiral Du Pont's unsuccessful bombardment of Fort Sumter in April 1863), and by the Union assault on Fort Wagner three months later, part of a concerted Union attempt to establish a foothold on the

Lieutenant William T. Glassell's *David* approaching the ironclad USS *New Ironsides*, October 5, 1863. Lookouts spotted their assailant when she was about 300yd from the Union ship. (Stratford Archive)

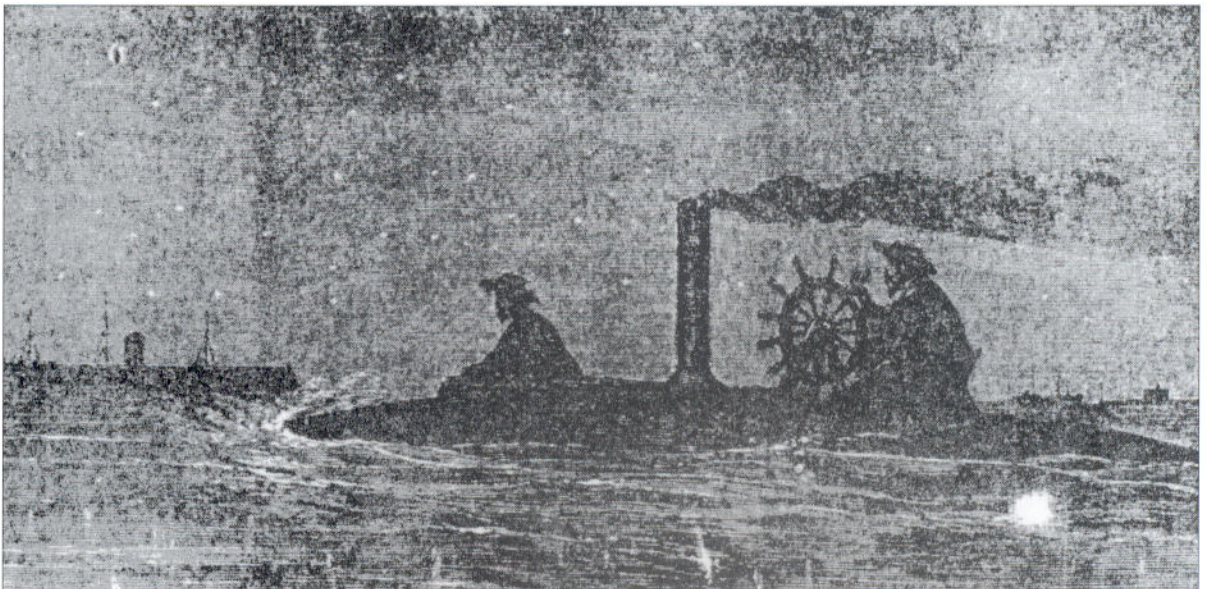

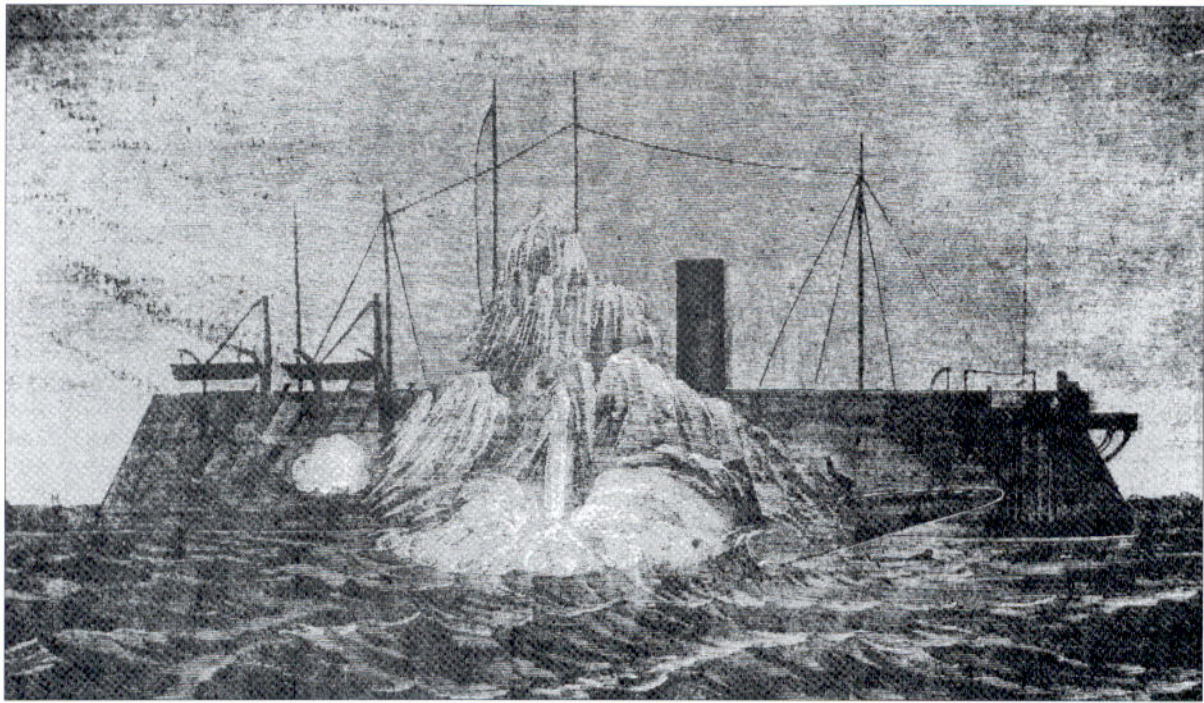

outskirts of Charleston Harbor. It was not until August that the CSS *Torch*, an improved steam-powered version of Lee's spar torpedo boat, commanded by Captain James Carlin, was able to successfully stalk the *New Ironsides*. On the night of August 20, 1863, Carlin ran past Fort Sumter on the ebb tide and around midnight he spotted the *New Ironsides* lying at anchor off Morris Island. He managed to approach the ironclad's starboard side without being seen, and he planned to turn toward her and drive his spar torpedo into her vulnerable bow (which was known to be unprotected by armored plate). A combination of the tide and his unresponsive helm conspired to make him miss the target, and he ended up entangled in the *New Ironsides*' anchor cable just when the enemy lookouts spotted him. At that moment the engine of the launch stopped, and for the next five minutes Carlin and his men were pinned there, subjected to an increasing fusillade of musket fire. Finally the engine was restarted and the Confederate launch steamed away to the safety of the shore.

This failure was largely due to the unsuitability of the attacking craft. Within weeks a far more suitable craft became available – a custom-built semi-submersible steam-powered torpedo boat which was brought into Charleston Harbor after being built some 30 miles above the city on the banks of the Cooper River. This vessel, the *David*, was the perfect craft for the job, and she was duly fitted with a spar torpedo. On October 5, Lieutenant W. T. Glassell and a crew of three (pilot, engineer, and fireman) took her to sea, and by 9pm she was a mile off Morris Island, just seaward of the line of blockading vessels, which were silhouetted by campfires on the shore. Glassell sighted the *New Ironsides*, lowered his spar torpedo, and attacked at full speed. Union lookouts spotted the *David* when she was just 300yd off the ironclad's starboard side, and in response to a challenge Glassell fired his double-barreled shotgun at

When Lieutenant Glassell detonated his torpedo, the USS *New Ironsides* was rocked by a huge explosion, while the *David* was almost swamped by the plume of water, which doused the fires in the furnace of the torpedo boat. From *Leslie's Illustrated Newspaper*, 1863. (Stratford Archive)

the ship. By some fluke the shot hit the *New Ironsides'* assistant officer of the deck, Acting Ensign C. W. Howard, who later died of his wounds. This caused confusion on board during the final seconds of the attack.

The *David's* engineer, J. H. Toomb, later reported:

In two minutes we struck the ship (we going at full speed) under the starboard quarter, about 15ft from her sternpost, exploding our torpedo about 6½ft from her bottom. The enemy fired rapidly with small arms, riddling the vessel, but doing us no great harm.

The torpedo struck the hull and exploded, shaking the *New Ironsides* and causing several casualties. Her armor plating saved her, and although the hull was buckled and damaged, she remained afloat, and the damage later turned out to be minor. The *David* was in worse shape, as the force of the explosion threw water all over her, which put out the fire in her boiler. It also dislodged her iron ballast, which was thrown in among the machinery. Drifting helplessly and under fire from Union sharpshooters, Glassell gave the order to abandon ship. Glassell and the fireman swam to the shore and were captured, but the pilot, J. W. Cannon, was unable to swim, so he remained on board the boat. By this stage, he had drifted



Charleston Harbor, South Carolina, during the Civil War. The *CSS H.L. Hunley* was based on the creek on the eastern side of Sullivan's Island, on the northern side of the harbor entrance. (Stratford Archive)

away from the enemy, and so he tried to relight the boiler fire. He was then joined by the engineer, who had at first swum away, but who now returned to help Cannon save the boat. Together they succeeded in restarting the engine, and crept back into Charleston. The effectiveness of the attack was later summed up by Union Rear-Admiral John A. Dahlgren, who wrote: "Nothing could have been more successful in a first effort, and it will place the torpedo among certain offensive means." As the Union's leading expert on naval ordnance, he knew what he was talking about. The offensively used torpedo was now a significant threat in naval warfare.

The *David* would make two more attacks on the enemy fleet. On March 6, 1864, she attacked the sidewheel steamer USS *Memphis* on the North Edisto River, and five weeks later she attacked the USS *Wabash* off Charleston (April 18, 1864). While neither attack succeeded, due to a combination of vigilant sentries and poor conditions, the potential for *David* smiting Union Goliaths remained until Charleston was abandoned in February 1865.

The attack of the CSS *H.L. Hunley*

On a moonlit night in February 1864, Lieutenant Dixon and seven Confederate submariners recruited from the Confederate Army made a daring attempt to break the Union blockade of Charleston. Dixon and his men had been ready for some weeks, but they waited for the right conditions, and selected the ideal target.

As one naval officer wrote:

There were any number of targets available for the spar torpedo. Close offshore, in a long line stretching down to the south and the way to the north, lay the blockaders. Anchored in a strategic berth, near the entrance to the Swash Channel, was the handsome sloop USS *Housatonic*. Unlike most of her sisters on the blockade, she

The sinking of the USS *Housatonic* by the CSS *H.L. Hunley* on February 17, 1864. The submarine can be seen close to the base of the explosion. From *Leslie's Illustrated Newspaper*, 1864. (Stratford Archive)

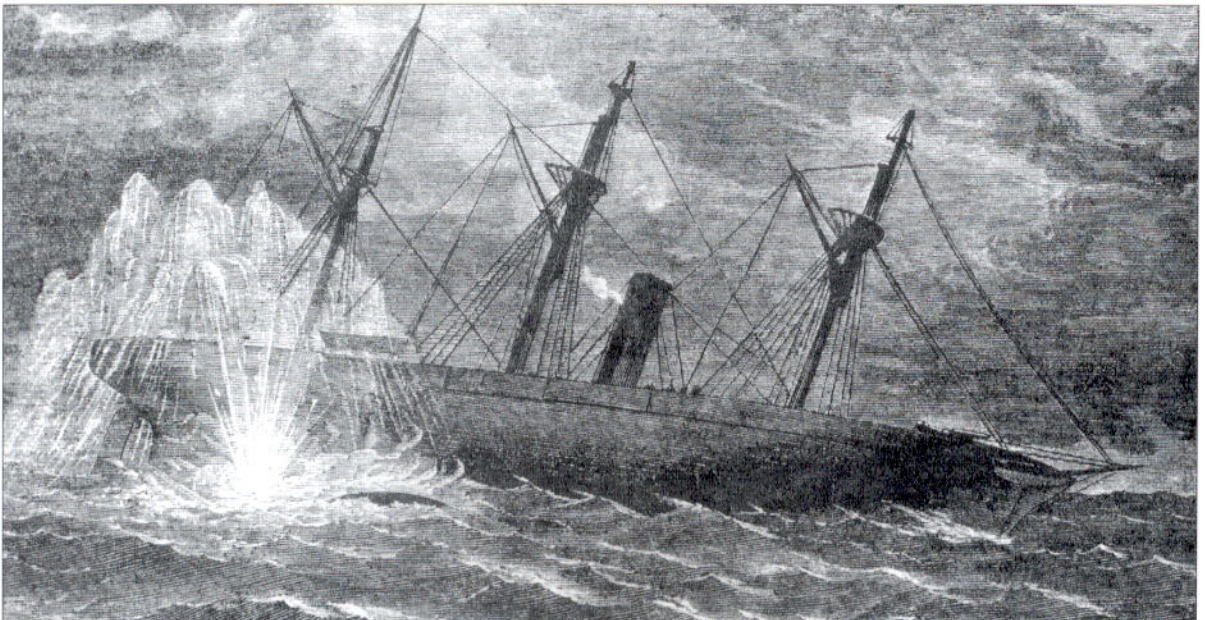

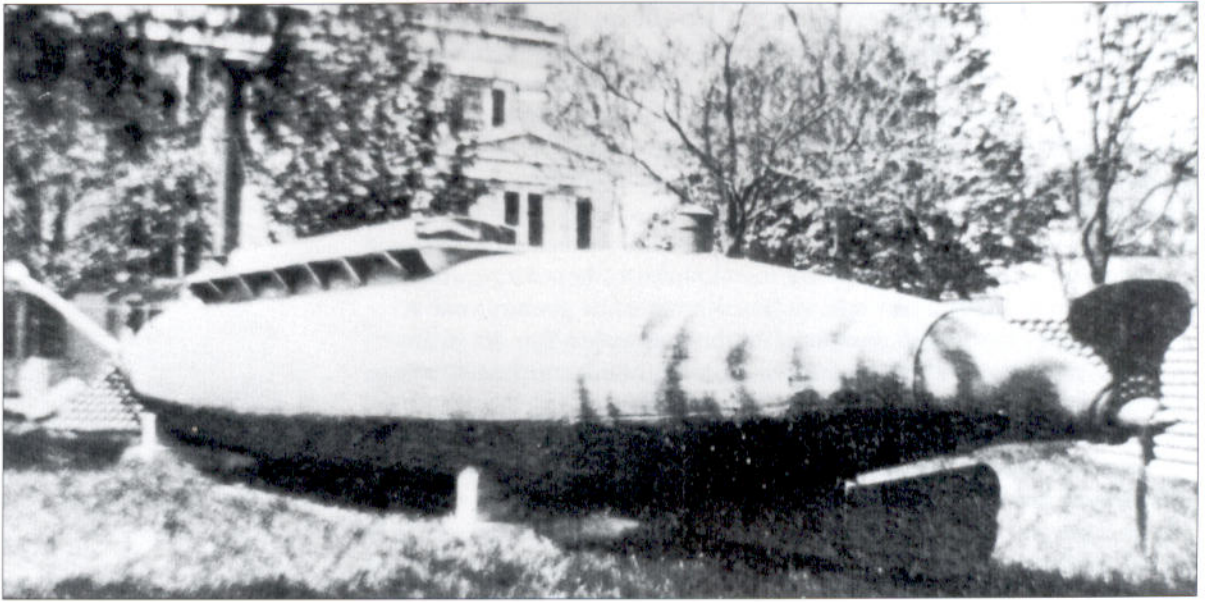

The semi-submersible torpedo boat CSS *Midge*, photographed around 1870 in the grounds of the Brooklyn Navy Yard, New York. This aspect shows the clean submarine-like lines of the vessel, which was designed to float with only her smokestack and wheelhouse combing protruding above the water. (US Naval Historical Center, Washington, DC)

was a regular warship, built for sea duty, with the rakish lines of a cruiser and the rig and armament of a small frigate. She was a genuine menace to any blockade runner looking for a safe path into the port.

On the evening of February 17, 1864, the submarine CSS *H.L. Hunley* cast off and headed down Breach Inlet on the east side of Sullivan's Island, a secluded spot on the northeastern fringe of Charleston Harbor. The tide was ebbing, which helped her crew as they propelled their craft out to sea. The sea was calm, and the waters of the harbor were moonlit. She headed south-south-east toward the *Housatonic*, her intended target, which was anchored some three miles from the shore. On Battery Marshall on the seaward end of Sullivan's Island, signal lanterns were prepared to guide the submarine home after her attack. The silhouettes of the blockading warships could be clearly seen from the shore, so the submariners would have had little problem in identifying their target.

On board the *Housatonic* the watch on deck had orders to remain vigilant, as earlier experiences with Confederate torpedo boats had shown the need for maintaining six lookouts and a quick response party with small arms at the ready. The vessel's guns were cast loose and provided (ready for action within a few minutes), with two rounds of grape, two of shell and two of canister, kept in readiness by each gun. In the engine room, steam pressure was maintained at 25psi, so that the engines could be engaged without any delay. As a final precaution, the anchor cable was rigged so that it could be slipped by a duty party of two seamen when required, meaning the vessel could get under way within a minute or so of the alarm being raised.

Just after 9pm, Master John Crosby, the officer of the watch, and his lookout saw something in the water a few yards off the starboard beam. It looked like a log, but on closer examination this "log" was moving steadily toward the starboard quarter of the warship, and its trunk had strange projections sticking out of it. Crosby ordered the duty drummer to beat

to quarters, then gave the command to slip the anchor cable. He also signaled the engine room to get the ship under way astern. It was a testimony to the efficiency of the *Housatonic's* crew that the ship was ready for action within three minutes, with guns manned and ready, and sharpshooters were in position along the starboard gunwale.

The *Housatonic's* commanding officer, Captain Charles C. Pickering, looked over the side:

I hastily examined the torpedo; it was shaped like a large whale boat, about 2ft, more or less, under the water; its position was at right angles to the ship, bow on, and the bow within 2 or 3ft of the ship's side, about abreast of the mainmast, and I suppose it was then fixing the torpedo on. I saw two projections or knobs about one third of the way from the bows. I fired at these, jumped down from the horse block, and ran to the port side of the quarterdeck as far as the mizzen mast, singing out; Go astern faster.

By that stage the strange object in the water had passed under the guns, and only the sharpshooters could still fire upon it. Ensign Charles Craven fired off two shots with his revolver, but to fire a third he had to lean out over the side of the ship. The attacker was under the starboard quarter just behind the mizzen mast, and appeared to remain there for a minute, then back away from the hull. Craven joined the gun crews, and:

tried with the captain of No. 6 gun (a 32-pdr smoothbore) to train it on this object, as she was backing from the ship, and about 40 or 50ft off then. I had nearly succeeded, and was about to pull the lanyard when the explosion took place.

There was a large crash and a muffled explosion, which Crosby likened to the report of a 12-pdr howitzer. It was followed by a far more severe

The New Orleans submarine, photographed shortly after she was recovered. The boat was originally fitted with a small conning tower, but only a hole remains there today. (Stratford Archive)

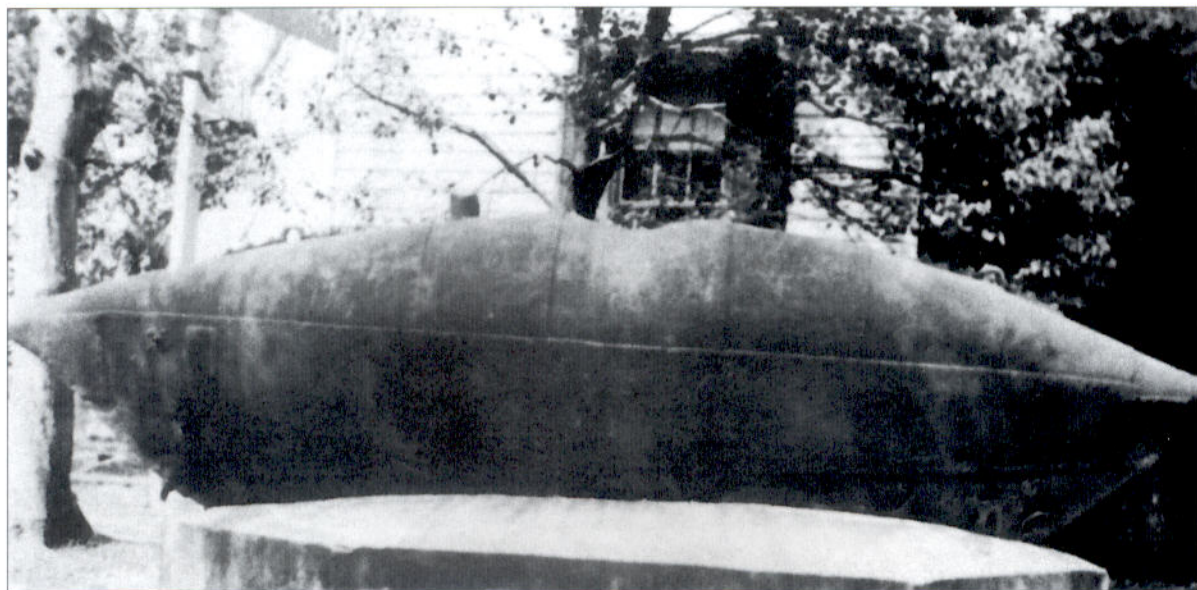

shock which lifted the sloop up by her stern. A dark column of smoke rose and pieces of timber flew as high as the top of the mizzenmast. The upper deck (the spar deck) lifted, then crumbled and fell apart from the mainmast aft. The engines were silenced by the explosion and, her hull shattered, the *Housatonic* went down quickly by the stern. Within two to three minutes she had sunk, her hull resting in four fathoms (24ft) of water, with only her masts remaining above the surface of the water. Somehow the majority of her crew managed to climb the rigging to safety. Surprisingly, the attack had gone unnoticed by the rest of the fleet.

From Craven's account it was clear that Lieutenant Dixon and his crew had managed to approach the *Housatonic*, secure their torpedo, then reverse away from the hull before detonating the charge. Unfortunately, Dixon was only about 50ft from the torpedo when it exploded, some 100ft closer than he had intended. What had gone wrong? The answer will remain a mystery. Possibly the reel jammed which linked the detonator to the torpedo, or Dixon was unnerved by the Union guns bearing on him and he exploded the device too early. We are also unaware of the immediate effect this had on the *H.L. Hunley*, as the explosion meant that the *Housatonic's* crew were too busy saving themselves to worry about their attacker. She was never seen again, at least for another 130 years. When her hull was raised in August 2000, both her hatches were closed, and there was no clear damage to her hull. Clearly the submarine had weathered the shockwaves created by the explosion, which makes her subsequent sinking even more of a mystery. It is hoped that archaeological evidence will be able to shed light on what happened during the *H.L. Hunley's* final moments.

Captain Pickering survived the explosion of his ship, and his crew had managed to launch two of the ship's boats before the explosion (they were usually fastened to her port quarter). He ordered one to be crewed, then was rowed over to the next warship in the Union line, the modern screw sloop USS *Canandaigua* (a half-sister ship of the *Housatonic*), which was moored 1½ cables (300yd) ahead of the *Housatonic*. The approach of Captain Pickering was the first her watch on deck knew of the disaster. The *Canandaigua* raised steam and moved alongside the wreck of the *Housatonic*, recovering 150 officers and men from the rigging. With the boat crew, that meant that 158 men survived the attack. Five of her crew went down with the ship, killed by the explosion or drowned when the engine compartments flooded.

Later, divers were sent to inspect the wreck. Although they found no evidence that the explosion came from an enemy torpedo, the divers

French inventor Brutus de Villeroi's submarine, pictured at the time of its seizure by police at Philadelphia in May 1861. This publicity stunt was successful, as it led to a government contract for a bigger, better submersible. (Stratford Archive)

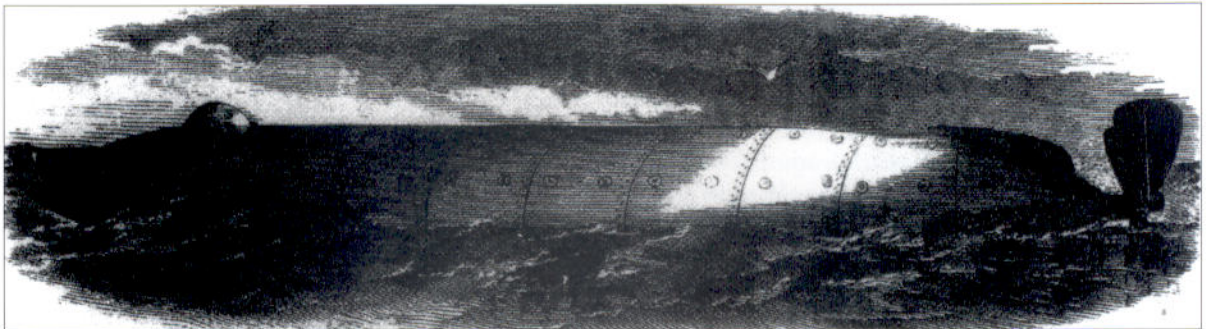

did confirm that the explosion had been caused by an external force, and had been a catastrophic one. It had destroyed everything abaft of the mainmast, ripping the hull apart, shattering bulkheads, cabins, and compartments, and collapsing the engine spaces. The rudder and sternpost were completely broken. Cabin furniture, bits of machinery, weaponry, and coal were scattered everywhere. The wreck was completely unsalvageable. In the subsequent court martial, Captain Pickering was exonerated of any blame, as the explosion was clearly the result of an attack by the "queer looking craft."

The Confederates were slow to realize the extent of their success. That night a sentry at Battery Marshall had spotted a blue light to seaward, the pre-arranged signal that the *H.L. Hunley's* attack had been successful, and according to Lieutenant Colonel Danzler, commanding the battery, the signal was answered. A Union sailor in the rigging of the *Housatonic* also spotted a blue light. That was the last contact anyone had with the submarine or her crew. The only Confederates who would have been able to tell the full story of what happened had disappeared, and the eight men would remain entombed in their lost submarine until the *H.L. Hunley* was recovered and raised in August 2000, five years after the vessel was relocated.

After the submarine had not returned to Breach Inlet by dawn the following day, her loss was confirmed. General Beauregard, commanding the Confederate garrison at Charleston, commended the crew of the *H.L. Hunley* for their valor, and officially named them as being lost in action. The Confederates remained unaware of the loss of the *Housatonic* for another ten days, when Union prisoners broke the news. Presumably the *Canandaigua* had blocked the protruding masts from view, and as warships were continually joining and departing from the Union fleet, the loss of any individual ship was difficult to ascertain. The newspapers proclaimed the attack to be a great victory, but it was clear that without the *H.L. Hunley* and her crew, the success could not be repeated. The Union blockade remained in place, and the only thing that really changed as a result of the attack was the future of naval warfare.

THE FORGOTTEN SUBMARINES

The publicity surrounding the dramatic loss of the *H.L. Hunley* and her equally dramatic rediscovery and excavation has helped to obscure the fact that she and her two predecessors were not the only submarines to be built during the Civil War. In fact, 20 or more submersibles were built by both sides during the conflict, although none enjoyed the success of the *H.L. Hunley*. Some of the most important of these are described below. Ragan (1999) provides a more extensive account of these forgotten boats.

The New Orleans submarine

In late June 1861, a woman from Buffalo, New York who had been teaching outside New Orleans when the war began, reported hearing of a submarine which was being built near the city. This predated McClintock's *Pioneer*. In 1879, a Civil-War-era submarine was recovered during dredging operations, and is now on display outside the Louisiana State Museum in New Orleans. It is most probably the craft described by the teacher. The

The experimental postwar submarine the USS *Intelligent Whale* was something of a disaster, sinking several times during her evaluation. The experience resulted in no further submarines being commissioned by the US Navy for three decades. (Stratford Archive)

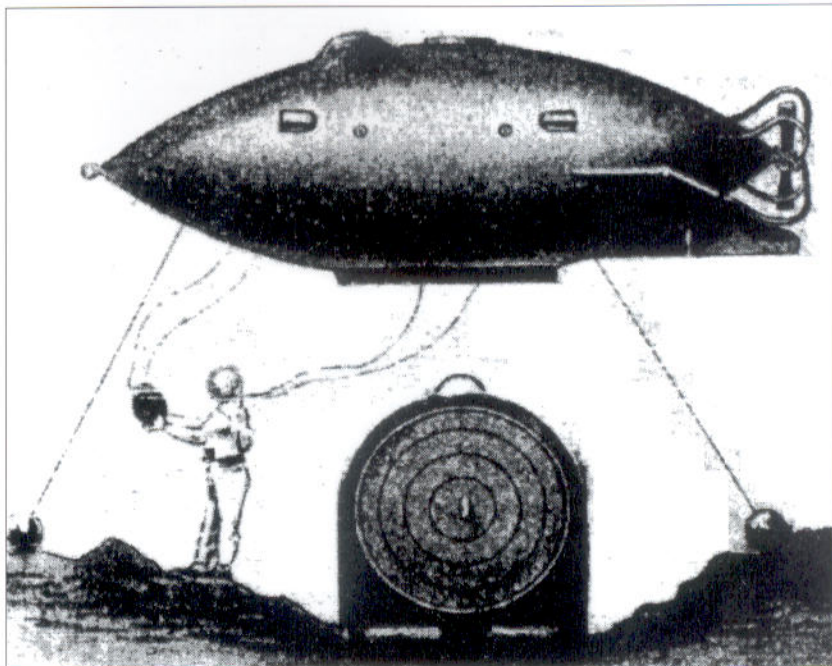

boat is 19ft 6in. from bow to stern, with a 6ft-high hull. A well-built craft, she was powered by a hand-cranked propeller and her bow fitted with a spar torpedo bracket. Although her builders are unknown, one historian noticed similarities between her and the privateering ironclad ram *Manassas*, which was built in New Orleans around the same time, and has suggested that the two craft were built by the same yard in Algiers, Louisiana.

Villeroi's first submarine

On May 16, 1861, a submarine was spotted in the Delaware River outside Philadelphia, and was boarded and seized by the police. She turned out to be a submarine built by the French inventor Brutus de Villeroi, who used her capture as a publicity stunt to attract the attention of the US Navy. She was duly inspected by naval engineers, who described her as being an iron cylinder 33ft long and 4ft in diameter. The boat never saw action, but Villeroi was awarded a contract to build an improved version of his craft.

Cheaney's submarine

In Richmond, Virginia, William Cheaney of the Confederate Department of the Navy designed a submarine which was built at the city's Tredegar Ironworks. In October 1861, she was tested in the James River, where she successfully destroyed an anchored barge. A sketch by Cheaney shows a vessel which may well be this boat, although no detailed dimensions survive. Air was provided by means of a tube which ran from the boat to a surface float. In November it is likely that she was transported to Norfolk, Virginia, then launched in an unsuccessful attack on the Union fleet at Hampton Roads. Her fate was recorded in a letter written by the Northern detective Alan Pinkerton: "I was informed that one of the vessels of the blockading fleet off the mouth of the James River had



Early on January 27, 1865, an object bumped alongside the sidewheel gunboat USS *Octorora* off Mobile Bay. A sailor grabbed the vessel's smokestack, and called for ropes to hold it fast to the side of the ship, but the heat of the smokestack forced him to let go. It was the submarine CSS *St Patrick*, which used a small steam engine to supply power when on the surface. (Stratford Archive)

discovered the float, and putting out her drag-rope, had caught the air tubes and thus effectually disabled the vessel from doing any harm, and no doubt drowning all who were on board of her." The submarine and her crew are still somewhere on the bottom of the James River. Cheeney worked on one more craft (probably armed with a prototype deck gun) during the summer of 1862, but he defected before she was ready for service and the project was abandoned.

The USS *Alligator*

In Philadelphia, Brutus de Villeroi had been working on his new submarine, which was launched in early May 1862. She was 40ft long, 6ft high, and 4ft 6in. in beam. Unlike his previous invention, this craft was powered by hand-cranked paddles. A watertight compartment in her bow allowed divers to enter and exit from the boat, while a crude carbon dioxide filter improved the quality of her air while submerged. On June 19, she was ready for service, and was christened the USS *Alligator*. She was

sent to Hampton Roads, where it was planned to use her in a daring attack up the Appomatox River to destroy a vital rail bridge. However, she was overtaken by the pace of events in the Peninsula Campaign, and instead she was towed to Washington, where she was modified, and Lieutenant Selfridge placed in charge of her. By March, she was ready for service again. The *Alligator* was being towed south toward Port Royal, South Carolina, when, on April 1, she was overtaken by a severe storm. The towing vessel, USS *Sumter*, was forced to cut the towing cable and abandon the unmanned *Alligator* south of Cape Hatteras. She was never seen again.

The USS *Intelligent Whale*

Another Union submarine entered service in the spring of 1866, too late to see service in the war. Designed by diving enthusiast Scovel Merriam and built by Cornelius S. Bushnell and Augustus Price's American Submarine Company in Newark, New Jersey, the USS *Intelligent Whale* was 30ft long, but her bulbous proportions permitted her to carry a crew of 13 men. However, she was nicknamed "Disastrous Jonah" after sinking three times during her trials, drowning her crews. She was decommissioned, but survived as a relic in Washington Navy Yard, where she can be seen today.

The CSS *St Patrick*

Apart from the *H.L. Hunley* and possibly William Cheeney's Richmond boat, the only other Confederate submarine to see action was the boat designed by Irish-born John Halligan and built in the Confederate Naval Yard in Selma, Alabama, during the spring and early summer of 1864. She was "shaped like a trout," 30ft long, probably with a beam of 6ft and a draft of 10ft. Like the *Pioneer II*, she was powered by a small high-pressure steam engine while on the surface. When she dived the engine would be cut off, and propulsion would be supplied by a more basic hand-crank. She was launched in the late summer of 1864, and after extensive trials she was commissioned the CSS *St Patrick* in early January 1865, then sent downriver to engage the Union fleet off Mobile. Under the command of Lieutenant John T. Walker she made a surface attack against the sidewheel gunboat USS *Octorora* early in the morning of January 27, 1865. However, her torpedo malfunctioned, and the attack was called off. She spent the last months of the war running supplies across the Alabama River from Mobile to Spanish Point, and it is probable the boat was scuttled when the war ended in April 1865.

BIBLIOGRAPHY

Only titles that deal specifically with the subject have been included here. See other New Vanguard titles on Civil War naval subjects for a more general bibliography.

Bak, Richard, *The CSS Hunley: The Greatest Undersea Adventure of the Civil War*, Taylor Publishing, New York, 1999

Campbell, R. Thomas, *Hunters of the Night: Confederate Torpedo Boats in the War between the States*, Burd Street Press, New York, 2001

Cussler, Clive, and Ragan, Mark K., *Submarine Warfare in the Civil War*, De Capo Press, New York, 2003



An unknown semi-submersible torpedo boat photographed in Washington Navy Yard after the war. It is possible that this was Torpedo Boat No. 6, the last and largest of the David Class, which was nearing completion when Charleston was abandoned to advancing Union forces in February 1864. (US Naval Historical Center, Washington, DC)

- Hicks, Brian, and Schuyler, Kropf, *Raising the Hunley : The Remarkable History and Recovery of the Lost Confederate Submarine*, Ballantine, New York, 2002
- Hoyt, Edwin P., *The Voyage of the Hunley*, Burford Books, New York, 2002
- Ragan, Mark, K., *The Hunley: Submarines, Sacrifice & Success in the Civil War*, Narwhal Press, Charleston, SC, 1995
- Ragan, Mark K., *Union and Confederate Submarine Warfare in the Civil War*, De Capo Press, New York, 1999
- Silverstone, Paul H., *Warships of the Civil War Navies*, Naval Institute Press, Annapolis, MD, 1989
- Still, Dr William N. (ed.), *The Confederate Navy: The Ships, Men and Organisation, 1861-65*, Naval Institute Press, Annapolis, MD, 1997

COLOR PLATE COMMENTARY

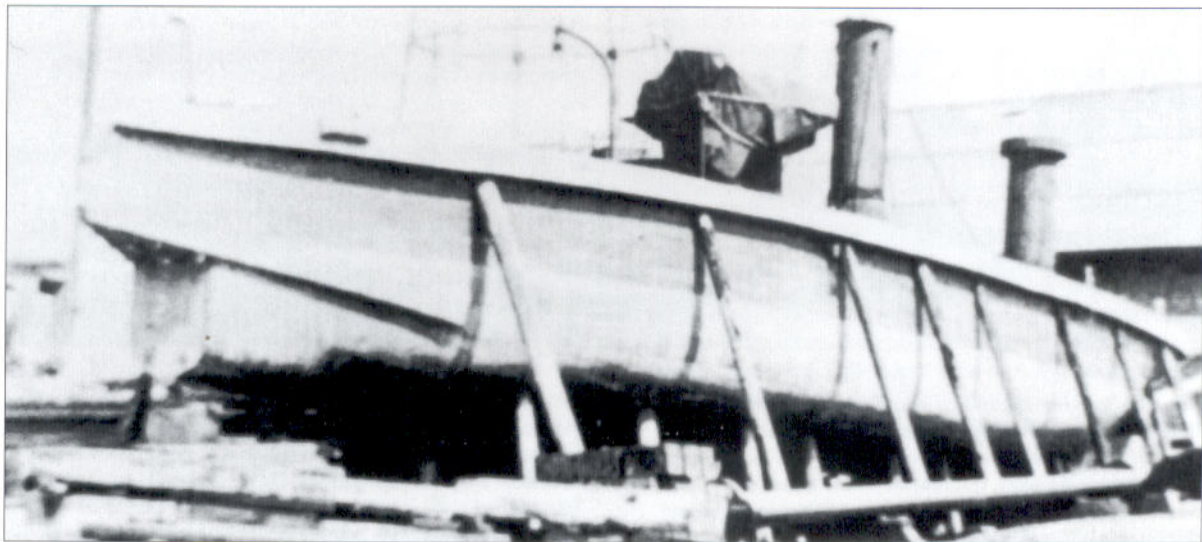

The USS *Spuyten Duyvil* in the dry dock of Brooklyn Navy Yard after the war. As her bow cutwaters have been removed, the flat plate covering her spar torpedo chamber is clearly visible. (US Naval Historical Center, Washington, DC)

A: TORPEDO BOAT CSS *DAVID*

Probably the most successful spar torpedo-boat design of the war, the *David* was produced as a private speculative venture by the Southern Torpedo Company, a business founded by Theodore Stoney and his partners. It was said their inspiration came by way of a \$100,000 bounty for anyone who could devise a means of sinking the USS *New Ironsides*, the most powerful vessel in the Union blockading fleet off Charleston. Certainly Stoney and his partners funded the venture themselves, and were repaid when the vessel was brought into service by the Confederate Navy. The result was a custom-built vessel, designed and constructed at Stoney Landing on the Cooper River in a matter of months.

The *David's* most striking feature was the submarine-like appearance of her hull, which was designed to ride so low in the water that the bow and stern were both submerged, like a modern submarine running on the surface. Although she was already designed to ride low in the water, water ballast tanks were fitted, and by partially flooding them the vessel's trim could be adjusted so that she rode as low as possible, leaving only her smokestack and wheelhouse combing above the water (see inset). This abnormally low freeboard caused problems; the *David* was swamped and sunk by a passing boat during her naval trials in September 1863. She entered service a few weeks later, and was first used in action in early October. After the initial *David*, several more slightly modified boats of the David Class were ordered, and these were all constructed along similar lines, although they were given numbers rather than names. The second inset shows how a spar torpedo was constructed. The device was set off by means of an artillery priming tube and a lanyard.

B: CSS *DAVID* ATTACKING USS *NEW IRONSIDES*, CHARLESTON HARBOR, OCTOBER 1863

Lieutenant William T. Glassell took command of the CSS *David* on September 23, 1863, and less than two weeks later, on the night of October 5, he used her to attack the USS *New Ironsides* off Charleston Harbor. His crew consisted of engineer J. H. Toomb, pilot J. W. Cannon, and a fireman, J. Sullivan. The torpedo boat approached undetected until she was just 300yd from the ironclad, and a few more seconds were lost when the officer on duty hailed the oncoming vessel. Glassell replied with a blast from his double-barreled shotgun and the *David* rammed her spar torpedo into the USS *New Ironsides*. It detonated under the starboard quarter of the ironclad, sending a shockwave which pummeled the little craft, and throwing high a column of water which then rained back on the *David*, putting out her furnace fires and threatening to swamp her. With her engine dead, the *David* hung under the quarter of the ironclad, a perfect target for the growing number of Union sharpshooters. Glassell gave the order to abandon ship, but her pilot was unable to swim, so he stayed on board. Toomb swam back to help him and together the two men managed to restart the *David's* engine and escape into the darkness.

C: TORPEDO BOAT USS *SPUYTEN DUYVIL*

Named after a narrow channel in southeast New York separating northern Manhattan Island from the mainland and linking the Harlem and Hudson rivers, the USS *Spuyten Duyvil* was the Union Navy's only purpose-built spar torpedo boat of the war. The 207-ton armored vessel was built at Mystic, Connecticut, her name recorded as the *Stromboli*, and she was delivered to the Brooklyn Navy Yard in October 1864. She was commissioned in the same month, as *Stromboli*, but her name was changed one month later. The original name was later allocated to one of the unsuccessful Casco Class monitors (which incidentally were also fitted

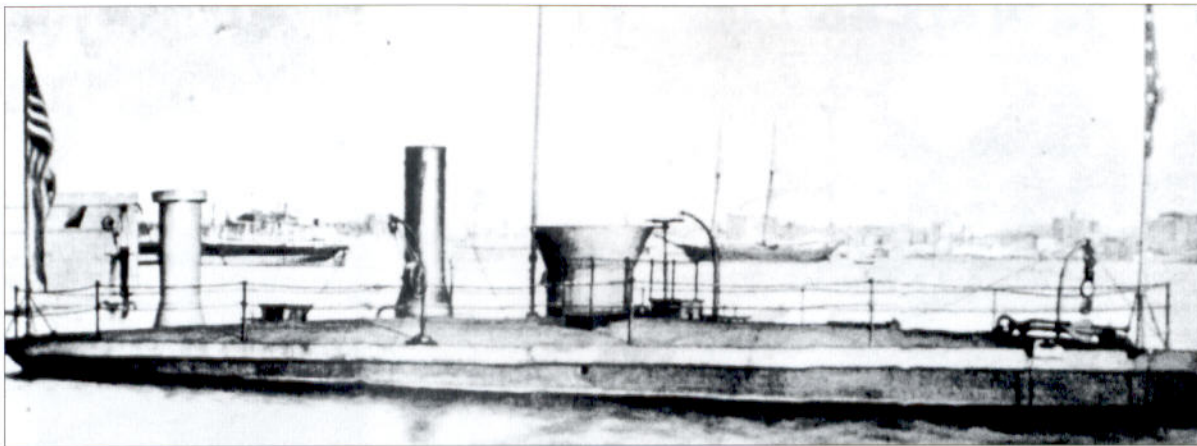

The USS *Spuyten Duyvil* in a sketch made in New York Harbor after the war. She continued to be used in an experimental capacity after the war, and was finally sold in 1880. Five years later, the first of a new breed of torpedo boats was laid down by the US Navy. (US Naval Historical Center, Washington, DC)

with spar torpedoes, although these were never used). After her arrival at Hampton Roads, Virginia, in early December 1864, *Spuyten Duyvil* operated on the James River. She subsequently participated in the Battle of Trent's Reach (January 1865) when she prevented a sortie down the river by a small squadron of Confederate ironclads and gunboats. For the rest of the war she was employed clearing obstacles on the James River by using her spar torpedo, a task she proved ideal for.

After the war ended she was sent to the Brooklyn Navy Yard, where she remained for the next 15 years, serving as an experimental vessel until she was finally sold out of the service in 1880.

D: SUBMARINE CSS *H.L. HUNLEY*

The first submarine to sink an enemy warship, the CSS *H.L. Hunley*, was named after one of her designers, the Confederate submarine pioneer Horace Hunley. Built in Mobile, Alabama, she was transported to Charleston, South Carolina, in August 1863, where it was hoped she would prove her worth by sinking some of the Union fleet blockading the Confederate port. Instead she herself was accidentally sunk on two occasions during the months that followed, taking some or all of her eight-man crew down with her on both occasions. Finally on the night of February 17, 1864, she successfully attacked and sank the enemy wooden screw sloop USS *Housatonic* using her spar torpedo. Although the attack was successful, the *H.L. Hunley* never returned to her base. She was rediscovered in 1995, and in August 2000 the *H.L. Hunley* was raised and brought ashore for conservation and excavation. Her eight brave crewmen were finally laid to rest with full military honors.

E: SUBMARINES CSS *PIONEER*, CSS *PIONEER II* AND USS *ALLIGATOR*

Probably the first submarine produced during the Civil War, the *Pioneer* was produced in New Orleans as a private

venture by a trio of Louisiana entrepreneurs, including Horace Hunley and James McClintock. She was never used in action, as she was finally finished and commissioned as a Confederate privateer (private, commerce-raiding warship) in late March 1862, just weeks before New Orleans fell to the Union. The boat was scuttled during the evacuation of the city, and her builders escaped to the safety of Mobile, Alabama, where they resumed their work. The *Pioneer* was raised by Union engineers, and her hull sold for scrap after the war.

Although no detailed plans survive, this representation is based on the sketch and description submitted to the Union Department of the Navy when the boat was examined in 1862. Like her successors, the *Pioneer II* and the *H.L. Hunley*, she was powered by a hand-operated winch, which turned a propeller, and hand-operated rudders and fins, which would have made her slow and difficult to steer, especially in the current of the Mississippi River. She carried a torpedo on a rack on her upper surface, which would have been screwed into the lower hull of an enemy ship by means of a detachable auger and cable, operated from the *Pioneer's* cockpit.

The inset shows the next collaborative effort by the three engineers. Built in Mobile, the *Pioneer II* (or *American Diver*) was unsuccessful, largely because her designers tried to push the boundaries of technology too far. Attempts to provide her with an electrical or a steam-powered engine proved costly failures, and she was finally fitted with another hand-powered propeller.

As a comparison, the Union submarine USS *Alligator* is also shown.

F: CSS *H.L. HUNLEY* ATTACKING USS *HOUSATONIC*, CHARLESTON HARBOR, FEBRUARY 1864

The first successful sinking of an enemy warship by a submarine, the attack of the *H.L. Hunley* against the Union wooden-hulled steam-powered sloop USS *Housatonic*, ranks as one of the great watershed in naval technological history. However, at the time it must have been a confusing affair, with neither crew fully aware of what was happening.

The boat approached the *Housatonic* unseen until she was within 50ft of her target. Once the *H.L. Hunley* was spotted, the slow approach of the craft gave the defenders

plenty of time to order the engines to go astern, and for the *Housatonic's* anchor cable to be cut. Marksmen ran to the side and began firing on the strange "log-shaped" object in the water, which although submerged was running with her hatch combings on the surface, as these could clearly be seen by the Union sailors. Lieutenant Dixon on the *Hunley* rammed the sloop, driving his torpedo into her side, then backed away. By this time, the Union gunners were almost ready for him, and as they prepared to fire, the lanyard attached to the torpedo was pulled and the device exploded. The *Housatonic* sank within minutes. The *H.L. Hunley* evidently survived the explosion, and she escaped amid the confusion. Unfortunately, the boat foundered on her way home, and Dixon and seven other crewmembers were lost.

The plate captures the scene just seconds before the explosion, after the *Hunley* had placed her torpedo and was about 50ft from the sloop.

G: TORPEDO BOATS CSS SQUIB AND CSS MIDGE

As well as the David Class spar torpedo boats built near Charleston, four Confederate spar torpedo boats of another class were constructed at the Tredegar Ironworks in Richmond, Virginia, during 1864. Although there is no indication that they were grouped together as a class at the time, naval historians sometimes collectively refer to these vessels as the Squib Class. Built under the guidance of Commander Hunter Davidson of the Department of the Navy's Torpedo Bureau, these craft were seen as a means to

attack the Union fleet operating in the lower James River, and the vessels anchored off the major Union naval base at Hampton Roads.

Unlike the David Class, these boats were notable for being of conventional construction. The vessel was a steam-powered launch with its machinery and smokestack mounted abaft the wheelhouse casing rather than in front of it. The leading edge and sides of the hatch combing were armored to give the crew some protection against small-arms fire, while a hand-crank could be used from the safety of the wheelhouse to lower the spar boom. Under the command of Commander Davidson, the *Squib* made an unsuccessful attack on the USS *Minnesota* off Hampton Roads, Virginia, in April 1864. The CSS *Scorpion* was damaged off Trent's Reach in January 1865, when she was captured and destroyed by Union troops. The CSS *Hornet* was lost in an accidental collision the same month, while the CSS *Squib* and the CSS *Wasp* were probably scuttled when Richmond fell.

Unlike the *Squib*, the CSS *Midge*, built in Charleston, was constructed along similar lines to the David class.

The iron-hulled experimental torpedo boat USS *Alarm* in dry dock, c. 1885. Commissioned nine years after the war ended, she could have represented a new breed of US naval torpedo boats, but she was overtaken by the invention of the steam-powered Whitehead torpedo, which necessitated the development of a new type of torpedo boat. (US Naval Historical Center, Washington, DC)

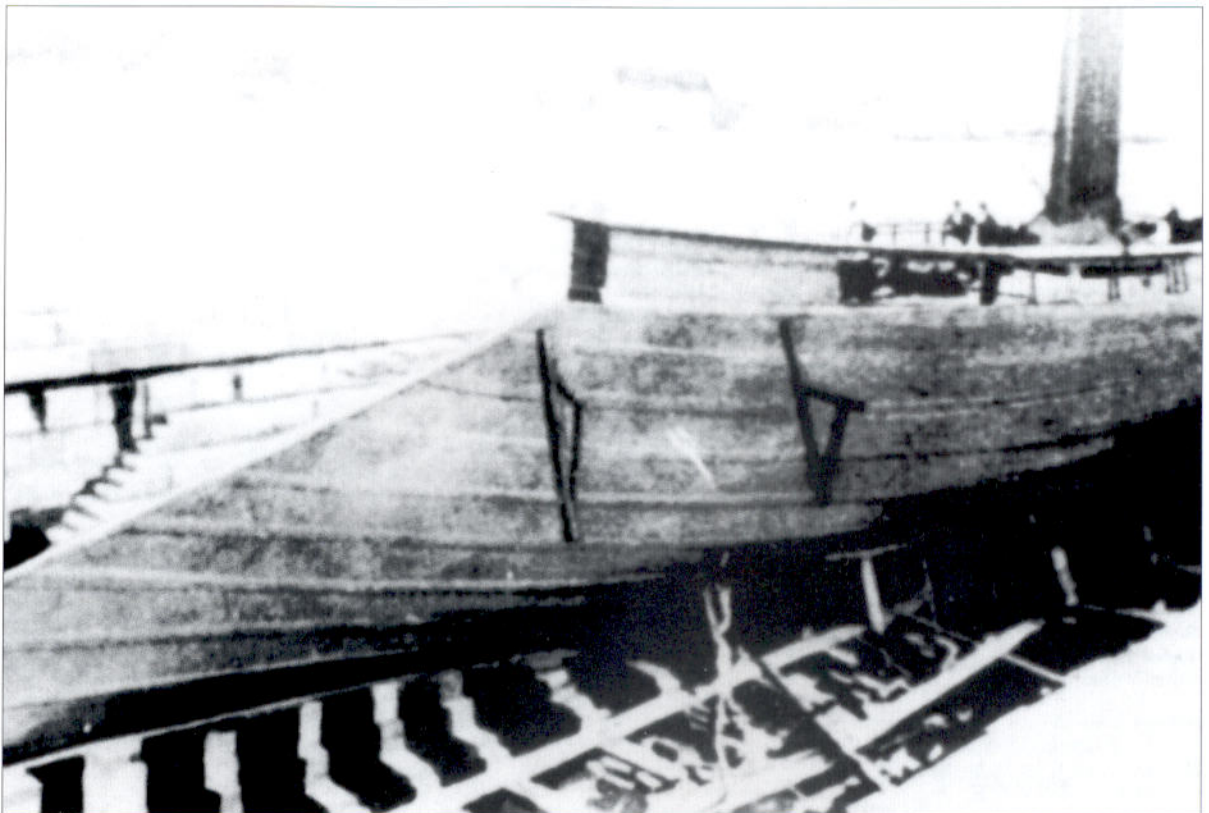

Figures in **bold** refer to illustrations

- Albemarle*, CSS 19, **20**, 33
 Alexander the Great 4
 Alexander, Lieutenant William A. 12, 14, 15–16
Alpha (tug) 19
 American Revolution 4, 21
 American Submarine Company 43
Arkansas, CSS 23
- Battery Marshall 37, 40
 Beaugard, General P. G. T. 6, 17, 18, 33, 40
Belle (tug) 19
 Breach Inlet 18, 37, 40
 Brooklyn Navy Yard 9, **10**, **37**, **45**, 46
 Brown, Isaac N. 23
 Buchanan, Admiral 13, 14, 17
 Bushnell, Cornelius S. 43
 Bushnell, David 4
- Canandaigua*, USS 39, 40
 Cannon, J. W. 35–6, 45
 Cape Fear River 9
 Carlin, Captain James 34
 Charleston 3, 8, **8**, **9**, **9**, 18, **22**, 23, 24, 33–4, **35**, 36, 37, 46
 Cheeney, William 41–2
Cold Mountain (film) 21
 Columbus, Georgia 20
 Confederate Navy 3, 20
 Confederate Patent Office 13
 Craven, Ensign Charles 38, 39
 Crimean War 22
 Crosby, Master John 37–8
 Cushing, Lieutenant William B. 19, 33
 Cussler, Clive 18
- Dahlgren, Rear-Admiral John A. 36
 Danzler, Lieutenant-Colonel 40
 Davidson, Commander Hunter 9, 23, **23**, 47
Delta (tug) 19
 Dixon, Lieutenant George E. 17, 18, 36, 39, 47
 Du Pont, Admiral 33
- Eagle*, HMS 4
- Faraday, Michael 21
 Fort Monroe 14
 Fort Sumter 33–4
 Fort Wagner 33
 Fulton, Robert 4, 20–1
- Gamma* (tug) 19
 Glassell, Lieutenant William T. 33, 34–5, 45
 Graves, William A. 20
- Halligan, John 43
 Hampton Roads 41, 43, 46, 47
Housatonic, USS 5, 18, 24, 36–40, **36**, 46–7, **F**
 Howard, Acting Ensign C. W. 35
Hoyt (tug) 19
- Hunley, Captain Horace L. 10, 12, 14, 16, 17, 18, 46
- James River 19, 41, 46, 47
 James River Squadron 9
 Jordan, Brigadier-General 6
- Kennon, Beverly 23
- Lee, Captain Francis D. 5, 6, 7, 24, 33
- McClintock, James R. 10–11, **11**, 12–13, 14, 17, 46
 Mallory, Stephen 3, **3**, 13, 22
Martin (tug) 19
 Maury, Commander Matthew Fontaine 23
Memphis, USS 36
 Merriam, Scovel 43
 mines and minefields 21, 22
Minnesota, USS 9, 47
 Mobile, Alabama 3, 12, 13, 14, 17, 23, 43, 46
 Morris Island 34
 Mystic River, Connecticut 18
- Napoleonic Wars 4, 21
 New Basin Dock, New Orleans 10
New Ironsides, USS 7, 21, **24**, 33–5, **33**, **34**, 45, **B**
 New Orleans 3, 10, 11, 12, 46
- Octorora*, USS 43
 Office of Ordnance and Hydrography 23
- Park and Lyons Machine Shop, Mobile 12, **13**, 17
 Payne, Lieutenant John A. 17
 Pee Dee River, South Carolina 20
 Petersburg, siege of (July 1864) 21
 Pickering, Captain Charles C. 38, 39
 Pinkerton, Alan 41–2
 Pook Ironworks, Connecticut 18
 Potomac River 22
Powhatan, USS 5, 33
 Price, Augustus 43
- Rains, Brigadier-General Gabriel J. 23
 Richmond, Virginia 9, 18, 20, 23, 41, 47
 Roanoke River **20**, 33
- Savannah 3, 23
 Scott, John K. 11, 12
 Selfridge, Lieutenant 43
 Shiloh, Battle of (April 1862) 17
 Shock, Mr 11–12
 Singer, Edgar C. 14, 23–4
 Singer Submersible Corp. 14
 Smith, Reverend Franklin 10, 11
 Southern Torpedo Company 7, 8, 45
 Stoney, Theodore 45
 Stoney Landing 7, 8
 Submarine Battery Service 23
 submarines
Alligator, USS 42–3, 46, **E**
- American Diver*, CSS 12, 46
 Brutus de Villeroi's **39**, 41
 Cheeney's 41–2
 development 4, 10
H. L. Hunley, CSS 4, 5, 14–18, **16**, **17**, **18**, **36**, 37–40, 46–7, **D**, **F**
Intelligent Whale, USS **41**, 43
 New Orleans **38**, 40–1
 newspaper depictions of **11**
Pioneer, CSS 10–12, **12**, 46, **E**
Pioneer II, CSS 12–14, **14**, **15**, 46, **E**
St Patrick, CSS **42**, 43
Turtle 4, 4
- Sullivan, J. 45
 Sullivan's Island 17, 18, 37
Sumter, USS 43
- Teaser*, CSS 23
 Toomb, J. H. 35, 45
- torpedo boats
Alarm, USS 19, **47**
 Alpha Class 19
David, CSS **7**, **9**, **33**, 34–6, **34**, 45, **A**, **B**
 David Class **7**, **8**
 development 3–4, 5
General Whiting, CSS 20
 Graves Class 20
Hornet, CSS 9, 47
Intrepid, USS 19
Midge, CSS 8–9, **10**, **37**, 47, **G**
 Nos. 1, 2 and 6 **8**, **44**
 Picket Launch No. 1 **19**, **20**
Scorpion, CSS 9, 47
 spar 5–6, **6**, 7, 19, 33
Spytzen Duyvil, USS 18–19, **19**, 45–6, **45**, **46**
- C**
Squib, CSS 9, **20**, **47**, **G**
Stromboli, USS 18, 45
Torch, CSS 6–7, 34
Viper, CSS 20
Wasp, CSS 9, 47
- Torpedo Bureau 9, 23, 24, 47
 torpedoes
 development 3–4, 21–4, 33
 Singer **15**
 spar 5, **5**, 7, 19, 20–1, **21**, 33, 34
 Tredegar Ironworks 9, 41, 47
 Trent's Reach, Battle of (January 1865) 19, 46
- Villeroi, Brutus de 41, 42
Virginia, CSS 3
- Wabash*, USS 36
 Walker, Lieutenant John T. 43
 Washington, George 4
 Washington Navy Yard 22, 43, **44**
 Watson, Baxter 10, 12, 14
 Whitney, "Gus" 14, 17
 Wilmington, North Carolina 9, 20, 23
 Wood, William W. W. 18
- Yorktown 23

The design, development, operation and history of the machinery of warfare through the ages



Full color artwork

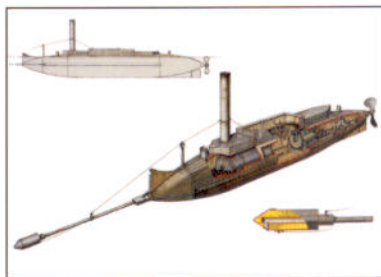

Cutaway artwork

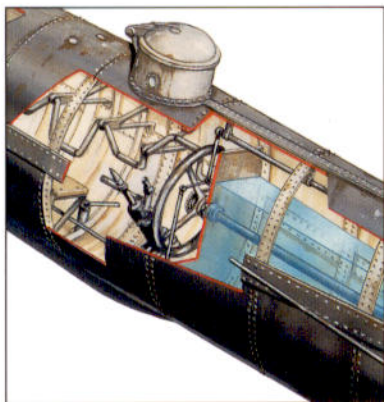

Unrivaled detail



Illustrations

Confederate Submarines and Torpedo Vessels 1861–65

The primary Union strategy during the American Civil War was a massive naval blockade of the entire Southern coastline of the Confederacy, and it was in the effort to counter this blockade that the Confederates developed their first submarines and torpedo boats. This book traces the development of these new technologies, including the CSS *Little David* and CSS *H. L. Hunley* – respectively the first torpedo boat and submarine to sink an enemy warship. The wreck of the *Hunley* was raised in 2000, and this is one of the first books to integrate details of its recovery and recent findings with an account of the submarines in action.

OSPREY
PUBLISHING

www.ospreypublishing.com

ISBN 1-84176-720-4



9 781841 767208

NOV
2004